

User Manual

Accessories for MELAtherm

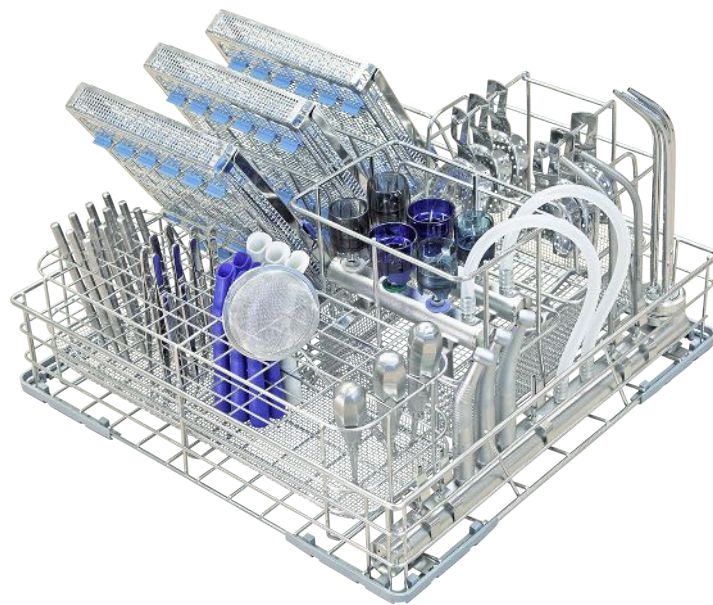

EN

Dear customer,

We thank you for your confidence demonstrated by the purchase of this MELAG product. As an owner-run and operated family concern founded in 1951, we have a long history of successful specialization in hygiene products for practice-based use. Our focus on innovation, quality and the highest standards of operational reliability has established MELAG as the world's leading manufacturer in the instrument reprocessing and hygiene field.

You, our customer are justified in your demand for the best products, quality and reliability. Providing **“competence in hygiene”** and **“Quality – made in Germany”**, we guarantee that these demands will be met. Our certified quality management system is subject to close monitoring: one instrument to this end is our annual multi-day audit conducted in accordance with EN ISO 13485. This guarantees that all MELAG products are manufactured and tested in accordance with strict quality criteria.

The MELAG management and team.

Contents

1 General guidelines	5
Symbols used	5
Formatting rules	5
2 Safety instructions	6
3 Instructions for reprocessing and use	7
Hollow-body instruments	7
Injector rail and distributors	7
Adapters for transmission instruments	7
Use of tools	7
Information for validation with a central filter	8
4 Optimising the cleaning performance and value-retention of the instruments	9
General notes	9
Wet/dry storage	9
Preparation and pre-cleaning	9
Loading instructions	10
Selecting suitable programs	10
Process agents	10
Routine checks	11
Servicing	11
5 Principles of the load configuration	12
The 6-segment principle	12
The Flex system	13
6 Accessories for exterior cleaning	14
Accessories overview	14
Basis baskets	21
Holders	23
Instrument and washing baskets	26
Stackable holder and baskets (Flex system)	31
Top frames and stackable baskets (Flex system)	36
Sieve cassettes and inlays	40
MELAstore Tray and silicone bars	42
7 Accessories for interior cleaning	44
Accessories overview	44
Connectors and adapters for instruments	52
Adapters for transmission instruments	58
Filter inserts	72
Injector rail with central filter and adapters	75
Sealing elements	79
Hoses and hose connections	81



8 Examples for the basic configuration	84
Basic configuration for an ENT practice	84
Basic configuration for the gynaecological practice	84
Basic configuration for the dental practice	85
Basic configuration for the general medical practice / surgery	85
9 Spare parts	86

1 General guidelines



Please read this user manual carefully before starting to use the accessories. The user manual includes important safety information. Make sure that you always have access to digital or printed version of the user manual.

Should the manual no longer be legible, is damaged or has been lost, you can download a new copy from MELAG download centre at www.melag.com.

Symbols used

Symbol	Explanation
	Indicates a dangerous situation, which if not avoided, could entail slight to life-threatening injuries.
	Draws your attention to a situation, which if not avoided, could result in damage to the instruments, the practice fittings or the device.
	Draws your attention to important information.

Formatting rules

Example	Explanation
Universal- Program	Words or phrases appearing on the display of the device are marked as display text.
	Prerequisites for the following handling instruction.
	Information for safe handling.

2 Safety instructions



When using the accessories in the washer-disinfector, comply with the following safety instructions as well as those contained in the subsequent chapters.

Instruments/accessories

- Before using the accessories for the first time, check them for manufacturing residues and damage. Clean the accessories in the washer-disinfector. To do this, run the “Rinsing” program without instruments.
- For your own safety and to avoid injuries, always wear personal protective equipment (PPE) or other suitable hand protection when loading and unloading instruments and washing baskets.
- Take care when arranging sharp and pointed instruments and do so in a manner that prevents all danger of injury. Loading should best be performed from back to front and unloading from front to back. Wear suitable protective gloves.
- Wear suitable hand protection when replacing filter elements in order to avoid contamination from soiled surfaces (e.g. by using a cleaning brush).
- Please note that instruments, instrument and washing baskets and other accessories can still be hot after the reprocessing.
- When spraying the instruments with the MELAjet spray pistol, make sure that the adapter is connected correctly and that the instruments to be sprayed are used properly, see the MELAjet user manual. Wear protective gloves and goggles.
- Only use instruments made of stainless steel or other non-corroding materials.
- Use only those instruments designed by their manufacturer for automatic reprocessing in a washer-disinfector. Please ensure that you observe the information provided by the instrument manufacturers according to ISO 17664. It is important to comply with the specifications from the instrument manufacturer regarding cleaning instruments for the first time after purchasing new instruments.
- Use original accessories from MELAG. We cannot provide a guarantee for non-MELAG accessories, even if they are in possession of validation.
- When using additional accessories from other manufacturers to secure instruments, especially hollow-body instruments, follow the instructions in the operating manual provided by the manufacturer of the accessories.
- If using accessories from other manufacturers, above all hoses, please ensure that they are heat-resistant up to 95 °C and resistant to the process agents used.
- Comply with pre-determined loading patterns established within the scope of the validation procedure.

Loading

- Ensure the correct arrangement of the instruments. Avoid unwashed areas and repeated stacking of the instruments.

Storage

- Store all accessories in a dry atmosphere protected from corrosive objects or media.
- Store the spare parts in a dry and dust-protected place, e.g. in the packaging.

Disposal

- Dispose of accessories if they show signs of wear (e.g. abrasion, cracks or corrosion) or damage (e.g. Deformation) to a great degree.
- Reprocess the accessories to be disposed of in isolation in the washer-disinfector before disposing of them.

Notification requirement in the event of serious accidents in the European Economic Area

- Please note that all serious accidents which occur in connection with the medical product (e.g. death or serious deterioration in the state of health of a patient) which were presumably caused by the product, must be reported to the manufacturer (MELAG) and the relevant authority of the member state, in which the user and/or patient resides.

3 Instructions for reprocessing and use



PLEASE NOTE

Observe national regulations regarding automatic reprocessing.

Hollow-body instruments

- To automatically reprocess hollow instruments, arrange them by adapters on the injector rail or by suitable load elements in the washer-disinfector in such a way that a sufficient flow is ensured. Universal dental aspirator tips with a 11 mm and 16 mm connection can be reprocessed in instrument baskets in a standing position. The distal end must point upwards. Take this into account during validation.
- After reprocessing, complex hollow bodies such as transmission instruments must be dried using medical compressed air to remove residual moisture.
- Before program start, check the instruments for a secure position on the adapters, the hose connections or the injector nozzles. The instruments must not be able to become detached during the program run. If this happens, they require further reprocessing in the washer-disinfector.
- When using the basis basket in conjunction with an injector rail, please ensure that you always push the basis basket against the rear wall of the chamber to the fullest extent, so that the injector rail locks on to the connection fitting on the inner wall of the washing chamber.
- Observe the information provided in the washer-disinfector user manual regarding transmission instruments and ophthalmological instruments.
- The operator is responsible for validating the procedure in combination with special load accessories. Pay special attention to the feed line to hollow-body instruments.
- Reprocess only those hollow-body instruments which guarantee sufficient and reproducible rinsing. Check the instruments for consistency and rinse thoroughly with running water (at least drinking water quality) before reprocessing.

Injector rail and distributors

- Sufficiently high rinse pressure is important for the cleaning. Always place instruments on the adapter. If possible, seal non-used adapters with the suitable silicone closure cap.
- Seal the unused connections on the injector rail and distributors with a screw plug (art. no. ME80140).

Adapters for transmission instruments

- Please note that leading manufacturers of transmission instruments recommend drying the spray/air/water channels immediately after reprocessing using medical compressed air. Ensure the free passage of the channels.
- Then carry out maintenance with care products/oils approved by the instrument manufacturer.

Use of tools

- If tools (e.g. an open-end wrench) are required for the application of accessories, use tools made of CrV steel.
- Only use tools if specified within the scope of the application to avoid damage to the accessories. Do not use damaged accessories for reprocessing.

Information for validation with a central filter

- Disinfect brand-new central filters (art. no. ME80490, ME84630) before validation in the device. The partial cycle "Disinfection" performed in maintenance mode is sufficient.
- The system conditions mean that the rinse pressure measured behind the central filter is lower than the rinse pressure measured in front of the device.
- Rinse pressures ≥ 100 mbar (measured behind the central filter) during cleaning and disinfection lie within the specifications.

4 Optimising the cleaning performance and value-retention of the instruments

The following important reprocessing instructions ensure that your washer-disinfector achieves the best possible cleaning performance and ensures the value-retention of your instruments. Further information is to be found in the brochure “Instrument Reprocessing” from the Arbeitskreis Instrumentenaufbereitung AKI (download from www.a-k-i.org) or from your instrument manufacturer.

General notes

- Please note that no preparations developed for commercially available dishwashers (e.g. dishwasher cleaners, household rinse aids or fragrance tabs) or other “home remedies” (e.g. aluminium foil as a stain preventative, vinegar or baking soda to improve odour) may be used in the washer-disinfector. These substances impair the reprocessing process and can cause damage to both the device and the instruments being processed. When metered correctly, the process agents specified by the washer-disinfector achieve the best possible cleaning effects and render superfluous the use of additional agents.
- Ensure that the coarse and fine sieves are inserted before removing the rinse arms. This prevents the entry of particles of dirt or rinse arms fastening parts into the pump pit.
- Check whether there are any small parts that have fallen down in the coarse and fine sieves before removing the sieves for cleaning. If necessary, remove small parts before removing them so that they cannot get into the interior of the appliance (note the risk of injury).
- Start the “Rinsing” program without load after each addition of regenerating salt to remove salt residues from the washing chamber.
- Avoid long downtimes (> 1 hour) after the “Rinsing” program.
- In case of longer breaks (> 2 weeks) you must bleed the metering pump hoses with water. Read and observe the information regarding these steps contained in the washer-disinfector user manual.

Wet/dry storage

Video tutorial

See also “Instrument preparation”.





- Store used instruments in a dry place. Ensure that they are stored protected from light and heat. Keep the storage duration as short as possible, according to AKI maximum 6 hours.
- Instruments which present organic residue (e.g. blood) after patient treatment could benefit from pre-soaking in a suitable treatment solution. Check that the process agent chosen for prior soaking is compatible with the washer-disinfector process agents. Otherwise, choose dry storage.
- If you perform pre-soaking, rinse the instruments thoroughly with running water before reprocessing in the washer-disinfector to prevent the solution from entering the device.
- Instruments may not be soaked overnight in water. Soaking in demineralised/distilled water is also associated with damage connected with treatment residue (blood etc.).

Preparation and pre-cleaning

- If instruments are to be subject to manual preparation for cleaning, ensure that no media or tools/resources are deployed which could damage their surface. Never use any aggressive cleaning agents, wire or brass wire brushes or metal scourers. Information regarding correct instrument reprocessing is available from your instrument manufacturer.
- Remove water-insoluble treatment substances (e.g. dental cement, root canal disinfectants, alginates or silicones) directly after use by manual cleaning. Consult the product data sheets of the treatment substances.
- Other substances can also necessitate manual pre-cleaning. These include ultrasound gels and other auxiliary substances.

- Check hollow bodies (transmission instruments, cannulas, etc.) for free passage. Observe the department-specific instructions in the user manual of the washer-disinfector.
- Disassemble dismountable instruments for reprocessing according to the manufacturer's instructions.
- Remove corroded or defective instruments. Crusted instruments must be subject to a basic cleaning or repair.
- KRINKO/BfArM (2012) recommend that instruments of the risk class "Semi-critical B" and "Critical B" are subjected to pre-cleaning directly after use.
- The complete cleaning and disinfection of surgical aspirators requires manual pre-cleaning of the interior lumen. Subsequent suction (e.g. using the dental unit) of a minimum of 200 ml water through the surgical aspirator immediately or 10 min (at the latest) after treatment will achieve sufficient pre-cleaning. A comparable or more intensive pre-cleaning is permissible.

Loading instructions

- In general, make sure that the load does not cause an unwashed area. When using third-party wash trays, make sure that the design of the wash trays (e.g. large covered areas) does not cause an unwashed area.
- Prepare instruments with joints that cannot be dismantled or instruments that can be closed (e.g. tweezers) in an open state.
- Place scratch-sensitive instruments (e.g. dental mirrors) separately with sufficient distance between them. Loose preparation in a wash tray can cause damage (e.g. to the mirror surface).
- If you use sieve cassettes, make sure that the instruments are rinsed around them. For this purpose, you can use the separation inlays for sieve cassettes (art. no. ME00191). Generally avoid "bulk material".
- Only reprocess instruments in the washer-disinfector that have been approved by the manufacturer. As a rule, these instruments are marked directly or in the reprocessing instructions with the following symbol: 
- If required, order the reprocessing instructions from the respective manufacturer in accordance with EN ISO 17664.
- Comply with the reprocessing instructions provided by the instrument manufacturer, especially those pertaining to compatibility with process agents.
- Do not reprocess any disposable instruments. Disposable instruments are usually marked with the following symbol: 
- Observe the information provided in the user manual regarding special instruments (dental transmission instruments, ophthalmological instruments, instruments with interior lumen).
- If you use non-MELAG accessories to reprocess instruments in the device, ensure that the compatibility of the accessories with the device and instruments.

Selecting suitable programs

- Normal up to strongly soiled instruments: **Universal-Program**
Use the **Intensive-Program** if the **Universal-Program** does not provide sufficient cleaning performance.
- Particularly heavily soiled instruments: **Intensive-Program**
- Unsoiled or only lightly-soiled instruments **Quick-Program**
- Ophthalmologic instruments: **Ophthalmo-Program**. **PLEASE NOTE:** DI water is required for this program.

Process agents

- To avoid cleaning problems, you must only use the compatible process agents that were set by the service technician when the washer-disinfector was installed. Information on the set device can be found in the record of installation and setup or on the information plate directly on the container.

Routine checks

- Regularly check the filters (e.g. in the adapters for transmission instruments) and sieves (coarse and fine sieve) and clean or replace them if necessary.
- Perform the routine checks in accordance with the user manual. The coarse and fine sieves should be checked for soiling and cleaned where necessary.
- Regularly check the plastic parts (e.g. inserts) for wear and replace them if necessary.
- Regularly check all accessories for damage. If necessary, dispose of damaged accessories properly.

After reprocessing

- Check the entire load to ensure that it has been successfully cleaned.
- Check adapters, hoses, connections and instruments to ensure that they are firmly seated. If an adapter, hose, connection or instrument has come loose, the respective instrument must be reprocessed.

Servicing

Interval	Measure	Accessories
Before every reprocessing	Check for firm seating	Basis basket incl. injector rail, adapters, hoses, connections
	Check for contamination and damage	All accessories
After each reprocessing	Check for dirt residues	All accessories
	Check for firm seating	Basis basket incl. injector rail, adapters, hoses, connections
	Function check	Control indicator of the injector rail
Every 2 weeks or after 20 cycles at the latest	Replacement and proper disposal	Ceramic filter disc
	Reprocessing (in ultrasonic bath)	Metal filter disc
After 20 reprocessing runs	Replacement and proper disposal	Metal filter disc
As required or after 12 months at the latest	Replacement and proper disposal	Plastic central filter
As required	Cleaning according to the control indicator of the injector rail	Cleanfinity filter
	Replacing the spare parts	Adapter for EMS AIR-FLOW Handy 3.0, Adapter for EMS AIR-FLOW Prophylaxis Master

Note the following:

- Only original MELAG spare parts may be used.

5 Principles of the load configuration

The 6-segment principle

All accessories are placed in the basis basket with or without an injector rail. The surface of the basis basket is divided into six segments to ensure the optimal use of space.

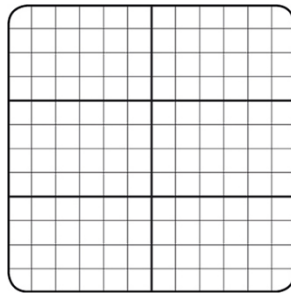

The size of all holders, instrument baskets, washing baskets and flex baskets correspond to one or more segments of the basis basket. One of the following illustrations is shown on the following pages:

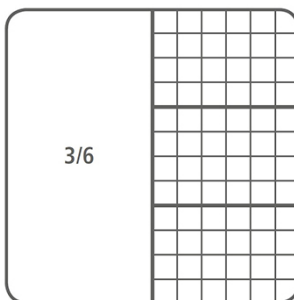
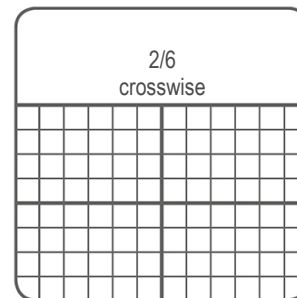
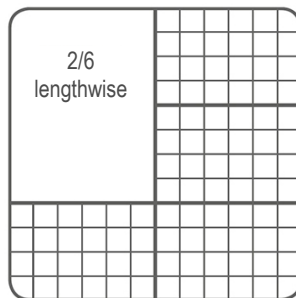
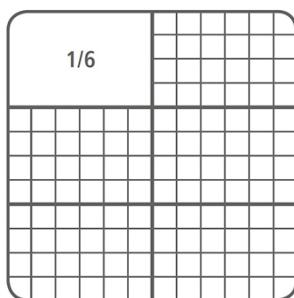

Application

- ▶ Always position the holders, instrument baskets, washing baskets and flex baskets to the left or right in the basis basket according to the 6-segment principle. Positioning in the middle of the basis basket is not recommended.

The Flex system

The Flex system was developed on the basis of the 6-segment principle. The Flex system consists of instrument baskets of various sizes. The flex baskets can be subject to variable combinations and stacked. This system ensures the optimal use of space in the washing chamber of the washer-disinfector.

Flex baskets may be stacked in a max. of two levels. Attachments for stackable flex baskets can also be used.



WARNING

Danger of unwashed areas

If more than two flex baskets are stacked on top of each other, unwashed areas can affect cleaning performance.

- Stack no more than a max. of two flex baskets.

The following example shows one of a number of many further possible combinations:

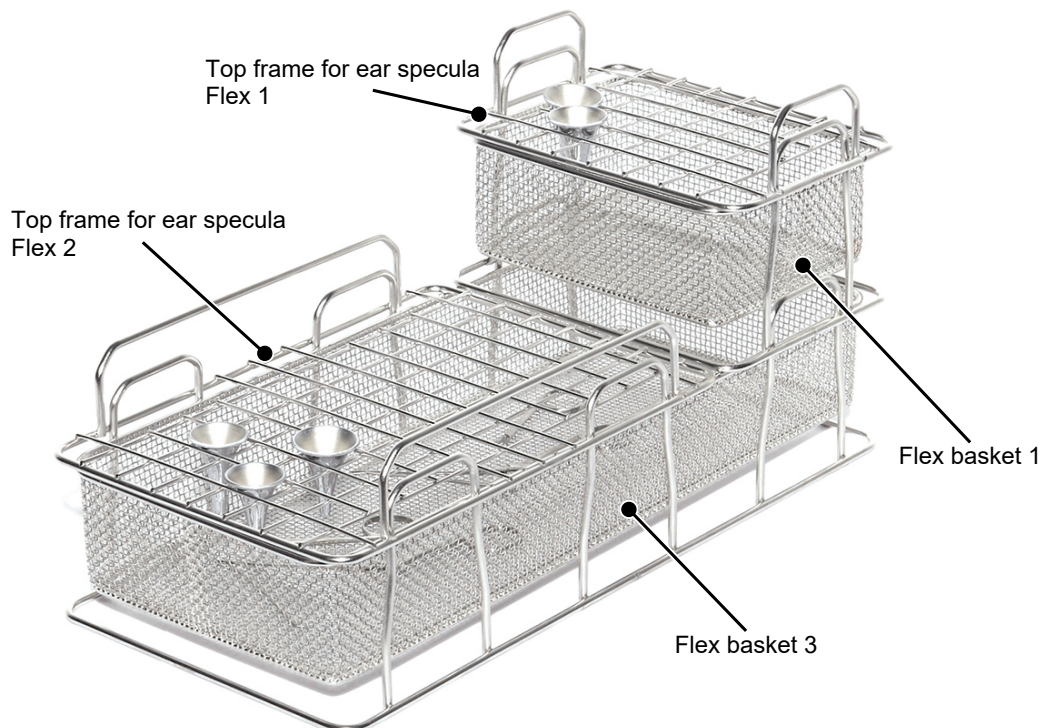

6 Accessories for exterior cleaning

Accessories overview

Basis baskets

Basis basket without injector rail

art. no. ME00188



see [Basis basket without injector rail](#) [▶ page 21]

Basis basket with injector rail

art. no. ME00200



see [Basis basket with injector rail incl. 11 blind screws](#) [▶ page 21]

Basis basket with injector rail incl. 11 injector nozzles and clamp springs

art. no. ME00197



see [Basis basket with injector rail incl. 11 injector nozzles and clamp springs](#) [▶ page 22]

Basis basket with injector rail incl. Cleanfinity filter

art. no. ME84610



see [Basis basket with injector rail incl. central filter](#) [▶ page 22]

Holder

Holder for 3 MELAstore Trays/ sieve cassettes

art. no. ME00180

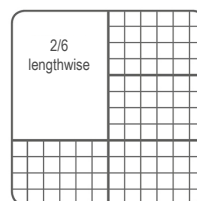
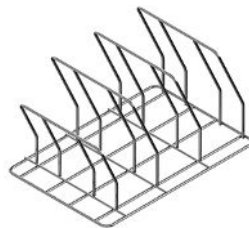

see [Holders for MELAstore Tray and sieve cassettes](#) [▶ page 23]

Holder for 4 MELAstore Trays/ sieve cassettes

art. no. ME80040

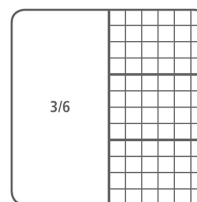
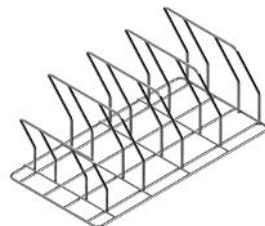

see [Holders for MELAstore Tray and sieve cassettes](#) [▶ page 23]

Holder for MELAstore
Tray 50/100
art. no. ME80810

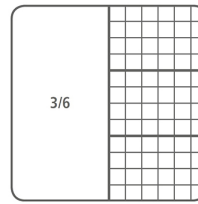

see [Holder for MELAstore Tray 50 \(12 pcs.\)](#)/[MELAstore Tray 100 \(6 pcs.\)](#) [▶ page 24]

Bracket for universal holder
art. no. ME80133



see [Bracket for universal holder](#) [▶ page 25]

Universal holder Flex 1
incl. 3 brackets
art. no. ME80134

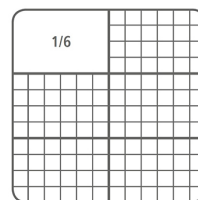
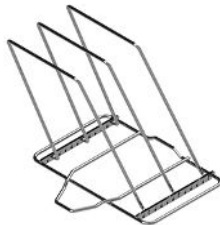

see [Universal holder Flex 1, 2 and 3](#) [▶ page 24]

Universal holder Flex 2
incl. 5 brackets
art. no. ME80135

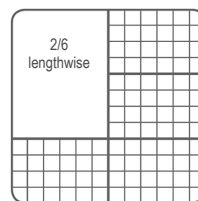

see [Universal holder Flex 1, 2 and 3](#) [▶ page 24]

Universal holder Flex 3
incl. 7 brackets
art. no. ME80136

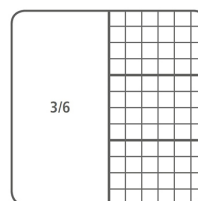
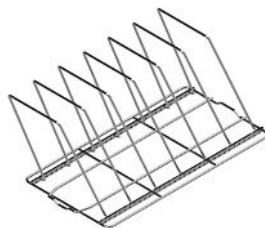

see [Universal holder Flex 1, 2 and 3](#) [▶ page 24]

Holder for 5 trays /
10 half trays
art. no. ME80590

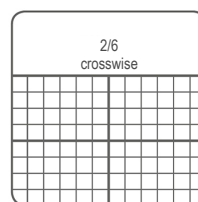
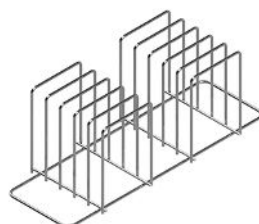

see [Holder for trays \(5 pcs.\)](#)/[half trays \(10 pcs.\)](#) [▶ page 26]

Instrument baskets and washing baskets

Instrument basket G
art. no. ME00131

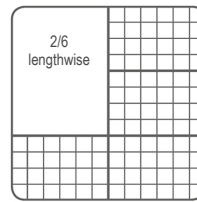

see [Instrument basket G, standard and compact](#) [▶ page 26]

Instrument basket standard
art. no. ME00184

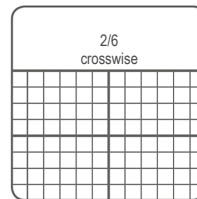

see [Instrument basket G, standard and compact](#) [▶ page 26]

Instrument basket compact
art. no. ME00195

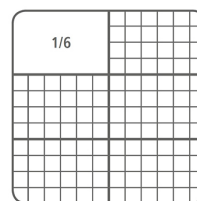

see [Instrument basket G, standard and compact](#) [▶ page 26]

Tip protection for instrument basket
art. no. ME00186



see [Tip protection for instrument basket](#) [▶ page 27]

Small parts basket Standard
art. no. ME00133



see [Small parts basket Standard](#) [▶ page 28]

Small parts basket
art. no. ME80001

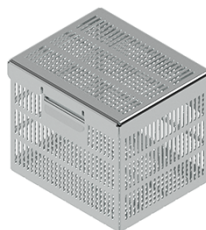

see [Small parts basket and insert for rotating instruments](#) [▶ page 28]

Insert rotating instruments
art. no. ME80002

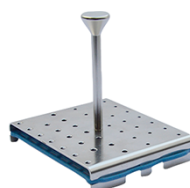

see [Small parts basket and insert for rotating instruments](#) [▶ page 28]

Silicone mesh for insert rotating instruments (2 pcs.)
art. no. ME22155

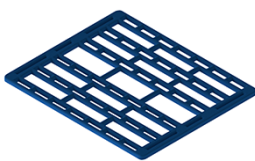

see [Silicone mesh for insert rotating instruments](#) [▶ page 29]

Stackable holder and baskets (Flex system)

Flex basket 1
art. no. ME80010

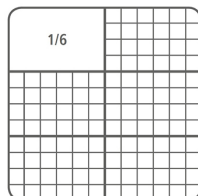

see [Flex basket 1, 2 and 3](#) [▶ page 31]

Flex basket 2
art. no. ME80020

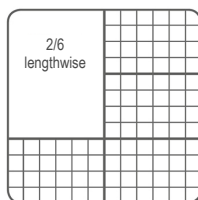

see [Flex basket 1, 2 and 3](#) [▶ page 31]

Flex basket 3
art. no. ME80030

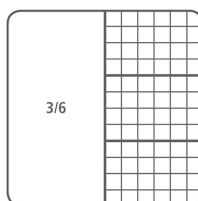

see [Flex basket 1, 2 and 3](#) [▶ page 31]

Flex basket 6
art. no. ME80255

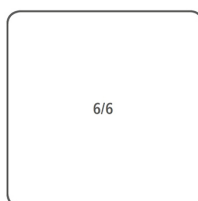
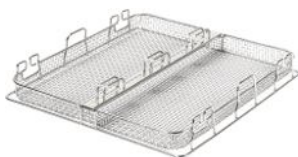

see [Flex basket 6](#) [▶ page 32]

Injector basket Flex 1
art. no. ME80740

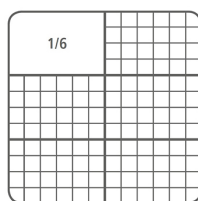
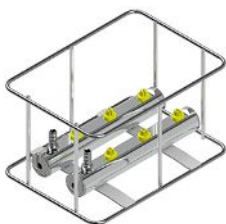

see [Injector basket Flex 1](#) [▶ page 32]

Holder for impression trays and instruments with joints
 art. no. ME80110*)
 *) has replaced the previous model (art. no. ME00182)

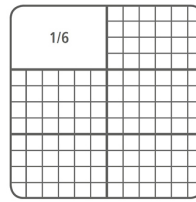
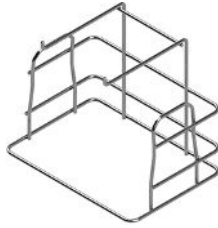

see [Holder for hinged instruments and impression trays](#) [▶ page 34]

Flex basket specula
 art. no. ME80410

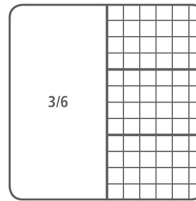

see [Flex basket specula](#) [▶ page 35]

Top frames for stackable baskets (Flex system)

Top frame for ear specula Flex 1 (mesh size 14 mm)
 art. no. ME80070

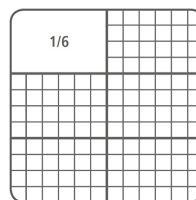

see [Top frame for ear specula Flex 1](#) [▶ page 36]

Top frame for ear specula Flex 1 (mesh size 20 mm)
 art. no. ME80080

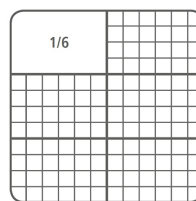

see [Top frame for ear specula Flex 1](#) [▶ page 36]

Top frame for ear specula Flex 2 (mesh size 20 mm)
 art. no. ME80090

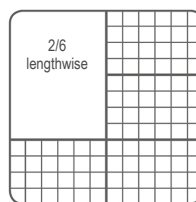

see [Top frame for ear specula Flex 2](#) [▶ page 37]

Top frame for ear specula Flex 3 (mesh size 20 mm)
 art. no. ME80100

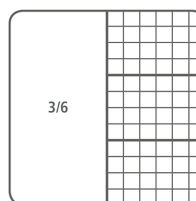

see [Top frame for ear specula Flex 3](#) [▶ page 37]

Top frame for nose specula
Flex 1 incl. 2 fixing clamps
art. no. ME80435



see [Top frame for nose specula Flex 1 incl. 2 fixing clamps](#)
[▶ page 38]

Fixing clamp for top frames
art. no. ME80420



see [Fixing clamps for top frame](#)
[▶ page 38]

Instrument holder for
Flex basket (60 pcs.)
art. no. ME80395



see [Instrument holder for flex baskets](#) [▶ page 39]

Sieve cassettes and inlays

a) Sieve cassette
art. no. ME00185

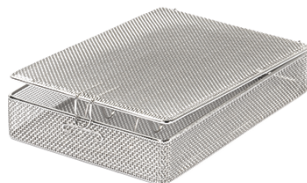

see [Sieve cassette](#) [▶ page 40]

b) Sieve cassette incl. separation inlay and protrusion guard
art. no. ME80185

Protection inlay for
sieve cassette
art. no. ME00189

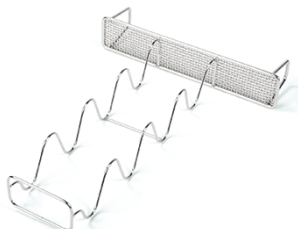

see [Protection inlay for sieve cassette](#) [▶ page 41]

Protrusion guard for
sieve cassette
art. no. ME00190

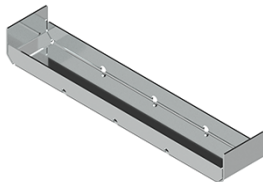

see [Protrusion guard for sieve cassette](#) [▶ page 41]

Separation inlay for
sieve cassette
art. no. ME00191



see [Separation inlay for sieve cassette](#) [▶ page 42]

MELAstore Trays and silicone bars

MELAstore Tray 50
(18.0 x 11.8 x 3.0 cm)

art. no. ME01180

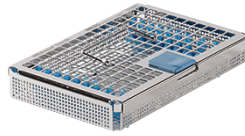

see [MELAstore Tray 50, 100 and 200](#) [▶ page 42]

MELAstore Tray 100
(27.5 x 17.6 x 3.0 cm)

art. no. ME01181

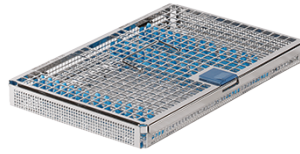

see [MELAstore Tray 50, 100 and 200](#) [▶ page 42]

MELAstore Tray 200
(27.5 x 17.6 x 4.3 cm)

art. no. ME01182

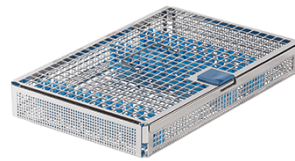

see [MELAstore Tray 50, 100 and 200](#) [▶ page 42]

Silicone bar for
MELAstore Tray 50

art. no. ME82960



see [Silicone bars](#) [▶ page 43]

Silicone bar wave profile for
MELAstore Tray 50/100

art. no. ME82961



see [Silicone bars](#) [▶ page 43]

Silicone bar for
MELAstore Tray 100

art. no. ME82970



see [Silicone bars](#) [▶ page 43]

Silicone bar downholder for
MELAstore Tray 50/100

art. no. ME82971



see [Silicone bars](#) [▶ page 43]

Silicone bar for MELAstore
Tray 200

art. no. ME82980



see [Silicone bars](#) [▶ page 43]

Basis baskets

The basis of every load variation is provided by the basis basket. All accessories are placed in the basis basket. Depending on the area of application, loading with holders, baskets etc. can be subject to any combination. For examples of basic configuration, see the chapter [Examples for the basic configuration](#) [▶ page 84].

Basis basket without injector rail

Video tutorial

See also “Basis basket: Without central filter”.



The basis basket without injector rail (art. no. ME00188) is used if no hollow-body instruments must be rinsed.



Basis basket with injector rail incl. 11 blind screws

The basis basket with injector rail (art. no. ME00200) is used when hollow-body instruments must be rinsed.

The hollow-body instruments are fastened to the injector rail using an adapter or other connection elements.

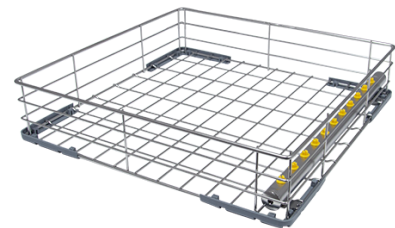

WARNING

Danger of contamination from insufficient disinfection

Use a filter insert for hollow-body instruments with an inside diameter ≤ 0.8 mm.

- Do not use the metal filter disc or the Cleanfinity filter in the ophthalmic area.
- Instead, use the ceramic filter disc or the plastic central filter.



PLEASE NOTE

Operation of the basis basket with injector rail and plastic blind screws (art. no. ME00200) is permissible only for the initial commissioning or max. three weeks. Afterwards, the blind screws must be replaced with stainless steel screw plugs (art. no. ME80140) or suitable accessories.

Basis basket with injector rail incl. 11 injector nozzles and clamp springs

The basis basket with injector rail incl. 11 injector nozzles and clamp springs (art. no. ME00197) is used when hollow-body instruments must be rinsed.

The hollow-body instruments (e.g. dental surgical aspirator tips) are stuck on the injector nozzles and fixed using clamp springs.

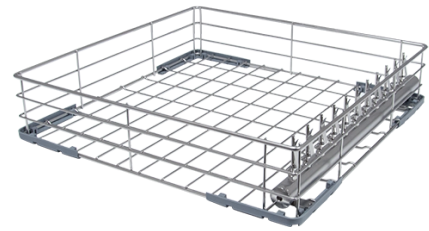

WARNING

Danger of contamination from insufficient disinfection

Use a filter insert for hollow-body instruments with an inside diameter ≤ 0.8 mm.

- Do not use the metal filter disc or the Cleanfinity filter in the ophthalmic area.
- Instead, use the ceramic filter disc or the plastic central filter.

Basis basket with injector rail incl. central filter

Video tutorial

See also "Basis basket: With central filter".



The basis basket with injector rail can be used either with the Cleanfinity filter (art. no. ME84610) or with the plastic central filter (art. no. ME80490). The basis basket is offered with injector rail and Cleanfinity filter as standard.

For further application instructions for the Cleanfinity filter and plastic central filter, see [Injector rail with central filter and adapters](#) [▶ page 75].



WARNING

The basis basket with injector rail may only be used with plastic central filter in ophthalmology.

The basis basket with injector rail and central filter is used for reprocessing hollow-body instruments with an interior diameter of ≤ 0.8 mm. The hollow-body instruments are connected to the injector rail using an adapter. The integrated control indicator of the injector rail indicates whether a minimum rinse pressure has been reached.



WARNING

Reduced rinse pressure

When using the basis basket with injector rail incl. central filter, do not use additional filter elements such as ceramic and metal filter discs.

- Before using a basis basket with injector rail incl. central filter, remove any existing filter elements.

Inserting the basis basket into the washing chamber

A fitting for connecting the injector rail or a blind cap is located on the right-hand rear side of the washing chamber of the washer-disinfector.

- ▶ Slide the basis basket with the injector rail opening or the blind cap leading into the washing chamber until it connects to the fitting.

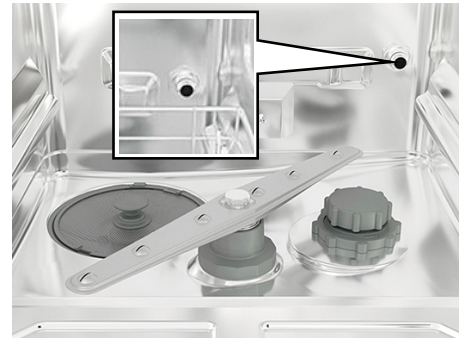

Inserting the basis basket

Holders

Holders for MELAstore Tray and sieve cassettes

The holders are used to hold up to 3 (art. no. ME00180) or up to 4 (art. no. ME80040) MELAstore Trays or sieve cassettes each. The holders are not stackable.

holder with sieve cassettes

We recommend use of MELAG sieve cassettes (see [Sieve cassette](#) [▶ page 40]). When using sieve cassettes from other manufacturers, please observe the corresponding usage advice.

1. Place the sieve cassettes in the holder with their closure pointing upwards. This prevents instruments from falling out downwards when removing the sieve cassettes if the lock opens.
2. Tilt the sieve cassettes in the holder towards the device door for easier loading and removal.



Holder with sieve cassettes

Holder with MELAstore Tray 200

The MELAstore Tray 200 is placed in the holder for 3 or 4 sieve cassettes.

- ▶ Place the MELAstore Tray 200 in the holder with the closure pointing to the rear.



Holder with MELAstore Trays

Used with

- Sieve cassette, art. no. ME00185
- Sieve cassette incl. separation inlay and protrusion guard, art. no. ME80185
- MELAstore Tray 50 (18.0 x 11.8 x 3.0 cm), art. no. ME01180
- MELAstore Tray 100 (27.5 x 17.6 x 3.0 cm), art. no. ME01181
- MELAstore Tray 200 (27.5 x 17.6 x 4.3 cm), art. no. ME01182

Holder for MELAstore Tray 50 (12 pcs.)/MELAstore Tray 100 (6 pcs.)

The holder (art. no. ME80810) is used to hold MELAstore Tray 50 and/or MELAstore Tray 100. The holder is not stackable.

Application**PLEASE NOTE**

Instruments must be disassembled for reprocessing according to the manufacturer's instructions.

A maximum of 6 MELAstore Tray 100 or 12 MELAstore Tray 50 (two stacked on top of each other) fit into the holder.

1. Place the MELAstore Trays in the holder with the closure pointing to the rear.
2. Tilt the MELAstore Trays in the holder towards the device door for easier loading and removal.

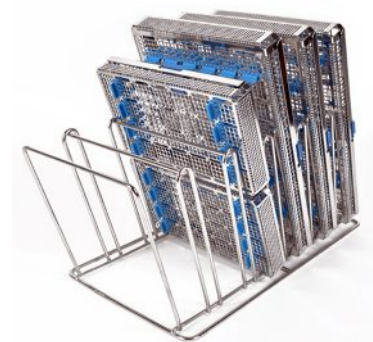

Loading with MELAstore Tray 50 and MELAstore Tray 100

Used with

- MELAstore Tray 50 (18.0 x 11.8 x 3.0 cm), art. no. ME01180
- MELAstore Tray 100 (27.5 x 17.6 x 3.0 cm), art. no. ME01181

Universal holder Flex 1, 2 and 3

The universal holder Flex 1 (art. no. ME80134), Flex 2 (art. no. ME80135) and Flex 3 (art. no. ME80136) can be used to hold sieve cassettes, MELAstore Trays, trays and kidney dishes. The universal holder is not stackable.

Application

Universal holder	Number of MELAstore Trays/sieve cassettes in the universal holder			
	MELAstore Tray 50	MELAstore Tray 100	MELAstore Tray 200	Sieve cassettes
Flex 1	4x	2x	1x	1x
Flex 2	8x	4x	3x	3x
Flex 3	12x	6x	5x	5x

Note the following:

- Only reprocess instrument trays which are cleared by the manufacturer for reprocessing in a washer-disinfector. If required, order the reprocessing instructions from the respective manufacturer.

1. Insert the required number of brackets (pos. a) into the base (pos. b) from the inside.
 - Choose a sufficiently large distance between the brackets to ensure proper rinsing of the load.
 - Make sure that you insert the brackets at the same height on both sides of the base.
 - Make sure that the brackets are tilted towards the base support (pos. c) to prevent the universal holder from tipping over.
2. Insert the universal holder into the washing chamber so that the brackets are inclined towards the device door.

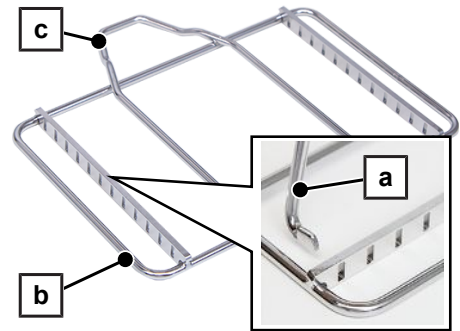

Insert the bracket into the base

Place the **sieve cassettes** in the holder with their closure pointing upwards. This prevents instruments from falling out downwards during removal if the closure opens. In the interests of simple loading and removal in the holder, the sieve cassettes should be inclined towards the device door.

Place the **MELAstore Trays** in the holder with their closure pointing to the rear. In the interests of simple loading and removal in the basis basket, the MELAstore Trays should be inclined towards the device door.

Remove the coarse soiling from the **instrument trays** before reprocessing in the device. Place several trays in the holder with the recess pointing in the same direction.

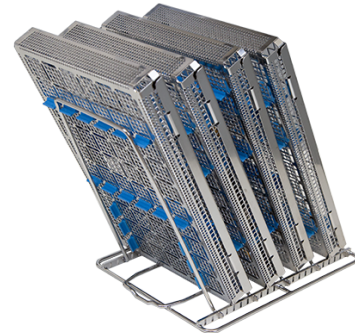

Universal holder Flex 2 with MELAstore Trays

Used with

- MELAstore Tray 50 (18.0 x 11.8 x 3.0 cm), art. no. ME01180
- MELAstore Tray 100 (27.5 x 17.6 x 3.0 cm), art. no. ME01181
- MELAstore Tray 200 (27.5 x 17.6 x 4.3 cm), art. no. ME01182
- Sieve cassette, art. no. ME00185
- Sieve cassette incl. separation inlay and protrusion guard, art. no. ME80185
- Bracket for universal holder, art. no. ME80133

Bracket for universal holder

The brackets (art. no. ME80133) are used to individually configure the universal holders Flex 1, Flex 2 and Flex 3. Sieve cassettes, MELAstore Trays, trays and kidney dishes can be inserted between the brackets for reprocessing with a universal holder.

Application

- ▶ Insert the brackets (pos. a) from the inside into the base (pos. b) of the universal holder.
 - Choose a sufficiently large distance between the brackets to ensure proper rinsing of the load.
 - Make sure that you insert the brackets at the same height on both sides of the base.
 - Make sure that the brackets are tilted towards the base support (pos. c) to prevent the universal holder from tipping over.

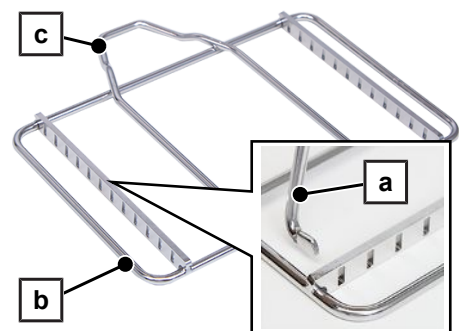

Inserting the bracket into the base

Used with

- Universal holder Flex 1, art. no. ME80134
- Universal holder Flex 2, art. no. ME80135
- Universal holder Flex 3, art. no. ME80136

Holder for trays (5 pcs.)/half trays (10 pcs.)

The holder (art. no. ME80590) is used to hold instrument trays with a maximum height of 20 mm. The holder is not stackable.

Application

Depending on the size, 5 to 10 instrument trays can be placed in the holder.

Note the following:

- Only reprocess instrument trays which are cleared by the manufacturer for reprocessing in a washer-disinfector. If required, order the reprocessing instructions from the respective manufacturer.
1. Remove the coarse soiling from the trays before reprocessing in the device.
 2. Always place multiple trays in the holder with the impression pointing in the same direction.



Loading with large and half trays

Instrument and washing baskets**Instrument basket G, standard and compact**

The instrument basket is used for reprocessing standing instruments e.g. tweezers, probes, mirrors, scissors, clamps, nose specula etc. The instrument basket cannot be stacked.

Universal dental aspirator tips with 11 mm and 16 mm connections can be treated in instrument baskets in a standing position. The distal end must point upwards. This must be considered separately during validation.

Application**CAUTION**

Danger of injury from sharp and pointed instruments.

The loading and unloading of pointed and sharp instruments can cause injuries if not handled properly.

- Wear suitable hand protection to avoid injuries during loading and unloading.

**PLEASE NOTE**

Instruments must be disassembled for reprocessing according to the manufacturer's instructions.

1. Remove heavy soiling on the instruments, such as adhering dental cement or similar materials, immediately after use on the patient.
2. Remove dried-on residues in an ultrasonic bath.
3. Place the instrument basket in the basis basket.
4. Insert all mirrors and other sensitive instruments in the instrument basket in such a fashion so that they do not cover each other or become damaged by banging into other instruments.
5. Place the instruments in the instrument basket with the grip ends pointing downwards.
PLEASE NOTE: For instruments with two working ends, MELAG recommends the use of the tip protection (art. no. ME00186).



Loading of instrument basket standard

Used with

- Tip protection for instrument basket, art. no. ME00186

Tip protection for instrument basket

The tip protection (art. no. ME00186) prevents pointed instruments from protruding or sliding through the meshing of the instrument basket.

Application

- ▶ Hook the tip protection into the lower level of the instrument basket lengthwise.

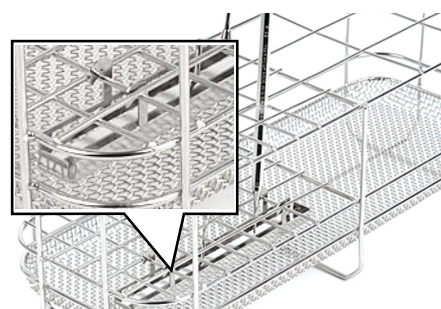

Instrument basket standard with tip protection

Used with

- Instrument basket G, art. no. ME00131
- Instrument basket standard, art. no. ME00184
- Instrument basket compact, art. no. ME00195

Small parts basket Standard

The small parts basket Standard (art. no. ME00133) is used for reprocessing very small instruments (e.g. drill bits) in order to prevent them from becoming lost in the washing chamber or blocking its apertures.

Application



PLEASE NOTE

For especially sensitive instruments e.g. endo instruments, MELAG recommends using the reprocessing accessories provided by their manufacturer.

1. Load the small parts basket with small instruments (e.g. drills) and lock the two half-shells with the catch (pos. a).
2. Place the small parts basket in instrument or flex baskets.



Small parts basket Standard

Used with

- Instrument basket G, art. no. ME00131
- Instrument basket standard, art. no. ME00184
- Instrument basket compact, art. no. ME00195
- Flex basket 1, art. no. ME80010
- Flex basket 2, art. no. ME80020
- Flex basket 3, art. no. ME80030

Small parts basket and insert for rotating instruments

The small parts basket (art. no. ME80001) is used to hold small instruments (e.g. drills) in an unordered manner or for loading with the insert rotating instruments (art. no. ME80002).

The insert rotating instruments is used to safely hold up to 38 rotating instruments (e.g. drills) with shaft diameters of 1.6 mm and 2.35 mm (up to 19 each). The rotating instruments are fixed by a silicone mesh underneath the insert, see [Silicone mesh for insert rotating instruments](#) [► page 29].



CAUTION

Danger of injury from sharp and pointed instruments.

The loading and unloading of pointed and sharp instruments can cause injuries if not handled properly.

- Wear suitable hand protection to avoid injuries during loading and unloading.



PLEASE NOTE

For especially sensitive instruments e.g. endo instruments, MELAG recommends using the reprocessing accessories provided by their manufacturer.

Application of the small parts basket without the insert rotating instruments

1. Load the small parts basket with small, unordered instruments (e.g. drills).
2. Close the lid.
3. Place the small parts basket in the flex basket 1, 2 or 3.

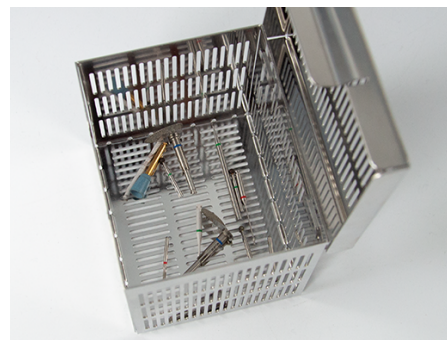

Small parts basket with unordered instruments

Application of the small parts basket with the insert rotating instruments

The small parts basket is used in combination with the insert rotating instruments to hold rotating instruments in an orderly manner.

Before reprocessing:

1. Load the insert rotating instruments first with short instruments and then with long instruments.
For proper loading, insert the instruments with the shaft first into the appropriate opening as far as it will go.
2. Place the insert rotating instruments in the small parts basket and close the container with the lid.
3. Place the small parts basket in the flex basket 1, 2 or 3.

After reprocessing:

- ▶ Remove the long instruments first and then the short instruments.

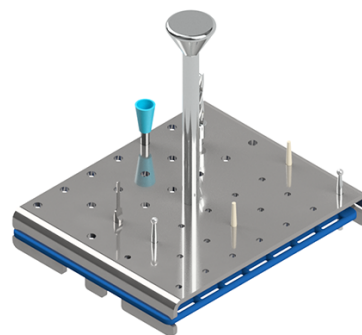

Loading the insert rotating instruments

Used with

- Flex basket 1, art. no. ME80010
- Flex basket 2, art. no. ME80020
- Flex basket 3, art. no. ME80030

Silicone mesh for insert rotating instruments

The rotating instruments are fixed in the insert rotating instruments from below by a silicone mesh (art. no. ME22155).

Routine check

1. Check the silicone mesh regularly for damage.
2. Replace the silicone mesh if necessary.

Replacing the silicone mesh

1. Reprocess the small parts basket including the insert rotating instruments and the old silicone mesh automatically.
2. Wait until the accessories have cooled down sufficiently after successful reprocessing.
3. Detach the outer meshes (pos. a) on both sides of the old silicone mesh from the tensioning tabs (pos. b) of the insert rotating instruments.
4. Rinse the new silicone mesh under running water.
5. Clamp the new silicone mesh under the insert rotating instruments. Pay attention to the orientation of the silicone mesh. The mesh sizes of the silicone mesh must correspond to the hole sizes in the insert rotating instruments.

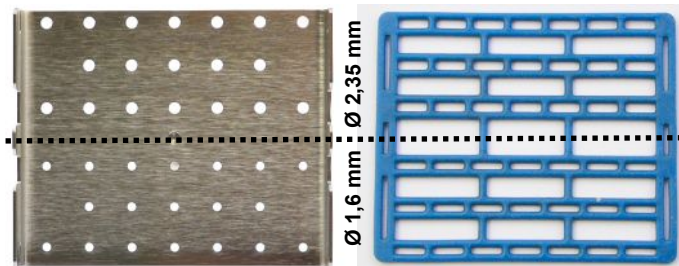

- ▶ The large meshes of the silicone mesh must be below the large holes (shaft diameter 2.35 mm) of the insert.
- ▶ The small meshes of the silicone mesh must be below the small holes (shaft diameter 1.6 mm) of the insert.

Used with

- Insert rotating instruments, art. no. ME80002

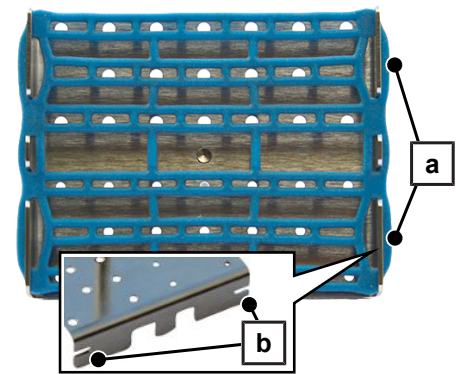

Loosening/clamping the silicone mesh



Shaft diameter 2.35 mm

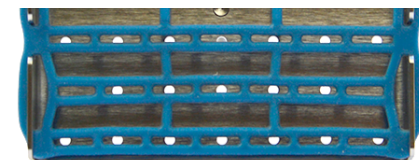

Shaft diameter 1.6 mm

Stackable holder and baskets (Flex system)

The flex baskets can be subject to variable combinations and stacked, see [The Flex system](#) [▶ page 13].

Flex basket 1, 2 and 3

The flex baskets (art. no. ME80010, ME80020, ME80030) are used for reprocessing instruments lying flat e.g. tweezers, mirrors, scissors etc.

Application

1. Place the flex basket in the basis basket.
2. Stack the flex basket in a maximum of two levels.

You can additionally use top frames for stackable flex baskets.



Loading flex basket 2



PLEASE NOTE

Reprocess hinged instruments such as scissors and clamps in the holders provided (art. no. ME80110) to optimise the cleaning result (see [Holder for hinged instruments and impression trays](#) [▶ page 34]).

Used with

- Flex basket 1, art. no. ME80010
- Flex basket 2, art. no. ME80020
- Flex basket 3, art. no. ME80030
- Top frame for ear specula Flex 1 (mesh size 14 mm), art. no. ME80070
- Top frame for ear specula Flex 1 (mesh size 20 mm), art. no. ME80080
- Top frame for ear specula Flex 2 (mesh size 20 mm), art. no. ME80090
- Top frame for ear specula Flex 3 (mesh size 20 mm), art. no. ME80100
- Holder for impression trays and instruments with joints, art. no. ME80110
- Injector basket Flex 1, art. no. ME80740

Flex basket 6

Flex basket 6 (art. no. ME80255) is used for reprocessing long instruments up to 40 cm e.g. cannulas, tweezers, scissors, trocars, suitable endoscope accessories etc.

Application

Flex basket 6 can be used as a basis under the flex baskets 1, 2, 3 and under the flex basket specula.

- ▶ Install the hoses free of kinks and sacks, preferably by using the hose conduit.

NOTICE! Do not clamp the hoses through other flex baskets.

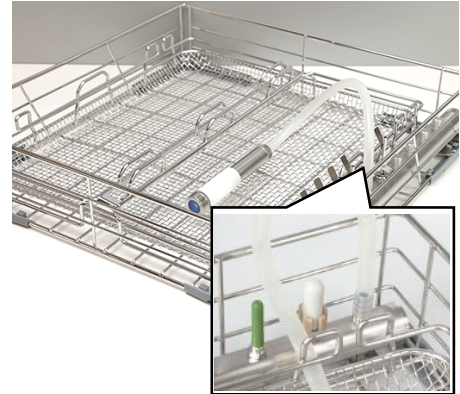

Flex basket 6 with hose conduit



PLEASE NOTE

Reprocess hinged instruments such as scissors and clamps in the holders provided (art. no. ME80110) to optimise the cleaning result (see [Holder for hinged instruments and impression trays](#) [▶ page 34]).

Used with

- Flex basket 1, art. no. ME80010
- Flex basket 2, art. no. ME80020
- Flex basket 3, art. no. ME80030
- Holder for impression trays and instruments with joints, art. no. ME80110
- Flex basket specula, art. no. ME80410
- Injector basket Flex 1, art. no. ME80740

Injector basket Flex 1

With **MELAtherm 10**, the injector basket Flex 1 (art. no. ME80740) is used exclusively for the cleaning of ultrasonic and air scaler tips.

With **MELAtherm 10 Evolution**, the injector basket Flex 1 (art. no. ME80740) is used for interior cleaning of ultrasonic or air scaler tips as well as transmission instruments.

Application



WARNING

Risk of contamination due to reduced cleaning performance

Failure to cover all the connections on the distributor can impair the cleaning result.

- Always place instruments on the adapters. Seal non-used adapters with the suitable silicone closure cap.
- Seal the unused connections with screw plugs (art. no. ME80140).



PLEASE NOTE

The use of the injector basket Flex 1 with plastic blind screws is only permitted for the first commissioning, maximum three weeks.

Note the following:

- The injector basket Flex 1 extends the connections of the injector rail. The injector basket Flex 1 may not be combined with further multi-way distributors.
- The instruments to be reprocessed with the injector basket Flex 1 require fine filtering of the rinse liquor. For this reason, the injector basket Flex 1 may only be used together with the filter disc housing or the central filter (Cleanfinity filter or plastic central filter).
- Max. three injector baskets Flex 1 may be inserted.

Reprocessing with a torque wrench connected is possible, as far as this has been approved by the manufacturer for automatic reprocessing.

The injector basket Flex 1 can be stacked on flex baskets 1, 2, 3 and 6.

1. Connect the injector basket Flex 1 via two connection hoses (pos. a) to two connections of the injector rail (with central filter) or two filter disc housings (injector rail without central filter).
PLEASE NOTE: Only use original accessories for the hose connection.
2. Screw the adapters for transmission instruments (only MELAtherm 10 Evolution) or tips into the free connections of the injector basket Flex 1.

Place the injector basket Flex 1 upside down if drainage of the wash liquor cannot be guaranteed.

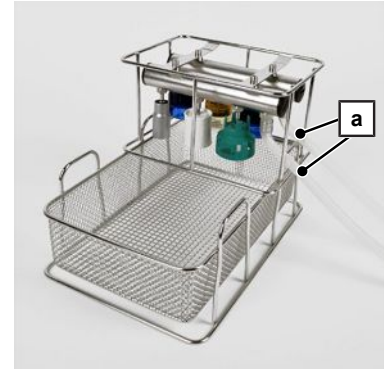

Flex basket 2 with injector basket Flex 1

Used with

- Filter disc housing incl. ceramic filter disc, art. no. ME73905
- Flex basket 1, art. no. ME80010
- Flex basket 2, art. no. ME80020
- Flex basket 3, art. no. ME80030
- Basis basket with injector rail incl. 2 plastic central filters, art. no. ME80440
- MELAtherm 10 Evolution only:
Adapters for transmission instruments, art. no. ME73904, ME80610, ME80612, ME80613, ME80614, ME80620, ME80630, ME80640, ME80650, ME80660
- Adapters for tips, art. no. ME80750, ME80751, ME80752, ME80753, ME80755, ME80756, ME80757, ME80760, ME80771, ME80790
- Basis basket with injector rail incl. Cleanfinity filter, art. no. ME84610

Holder for hinged instruments and impression trays

The holder is used for reprocessing up to 8 dental impression trays as well as scissors, clamps and similar hinged instruments.

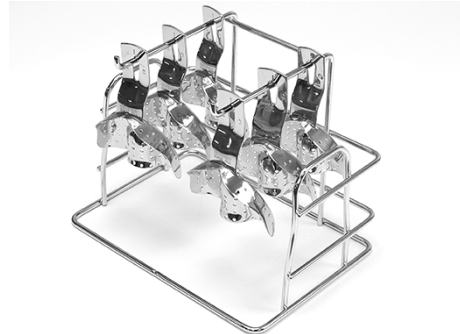
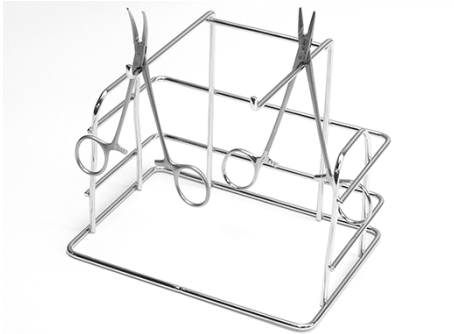

Application



CAUTION

Danger of injury from sharp and pointed instruments.

The loading and unloading of pointed and sharp instruments can cause injuries if not handled properly.

- Wear suitable hand protection to avoid injuries during loading and unloading.

The holder can be stacked with longer scissors, clamps and similar hinged instruments above flex baskets 1, 2, 3 and 6.

1. Hang the impression trays one after the other on the hooks.
2. Hang the scissors, clamps and similar hinged instruments spread and with the processing end down in the holder or place them on the brackets.
3. Place the holder in the basis basket.



Hinged instruments rest on the brackets.



PLEASE NOTE

Long pointed objects can push through the basis basket, thus blocking the rinse arm.

- Ensure that the rinse arm can turn. If necessary, the instruments can be distributed in other flex baskets.

Used with

- Flex basket 1, art. no. ME80010
- Flex basket 2, art. no. ME80020
- Flex basket 3, art. no. ME80030
- Flex basket 6, art. no. ME80255

Flex basket specula

The flex basket specula (art. no. ME80410) is used for reprocessing up to 8 Kristeller specula or 16 Cusco/Semm specula.

Application

Up to 2 flex baskets specula can be stacked next to each other on flex basket 6.

- ▶ Place the flex basket specula in the basis basket.



Loading the flex basket specula

Instructions for Kristeller specula:

The arches in the longitudinal struts of the standard instrument basket serve on the one hand as a centre fixation and on the other hand as a separating device.

1. Position each wide Kristeller specula so that it is fixed in the basket with the help of an arch.
2. Position narrow Kristeller specula each next to an arch to fix them separately in the basket.

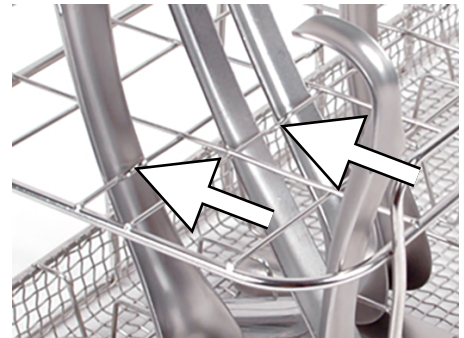

Positioning Kristeller specula on arches

- ▶ Increase the inclination for short instruments to achieve better drainage. To do this, place the ends of the Kristeller against the longitudinal strut at the bottom of the standard instrument basket.

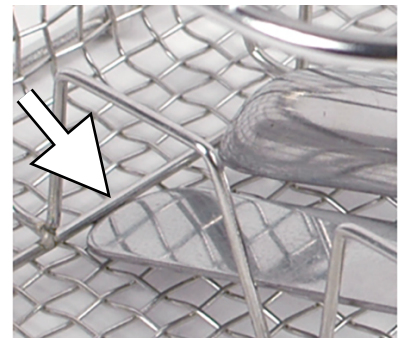

Positioning short Kristeller specula

Instructions for Cusco/Semm specula:

- ▶ Hang the Cusco specula spread and over the longitudinal struts.



Loading with Cusco/Semm specula

Used with

- Flex basket 6, art. no. ME80255

Top frames and stackable baskets (Flex system)**Top frame for ear specula Flex 1**

The top frame is used for reprocessing up to 24 (art. no. ME80080) or up to 50 (art. no. ME80070) ear specula in combination with a flex basket.

Application

You can use the top frame with flex baskets 1, 2 or 3 as you like, partly equipped or overlapping, see [The Flex system](#) [▶ page 13].

1. Place the top frame (pos. a) on flex basket 1, 2 or 3.
2. If required, fix the top frame in place with fixing clamps, see [Fixing clamps for top frame](#) [▶ page 38].
3. Hang the ear specula (pos. b) with the pointed side down in the spaces.

PLEASE NOTE: Ensure that the ear specula do not come into contact with each other.

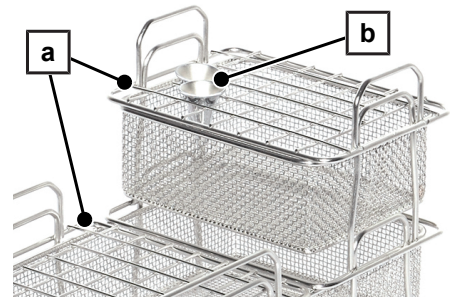

Flex basket 1 with top frame for ear specula Flex 1

Used with

- Flex basket 1, art. no. ME80010
- Flex basket 2, art. no. ME80020
- Flex basket 3, art. no. ME80030
- Fixing clamp for top frames, art. no. ME80420

Top frame for ear specula Flex 2

The top frame (art. no. ME80090) is used for reprocessing up to 60 ear specula in combination with a flex basket.

Application

You can use the top frame with flex baskets 1, 2 or 3 in any combination, e.g. one top frame on two flex baskets 1.

1. Place the top frame (pos. a) on flex basket 1, 2 or 3.
2. If required, fix the top frame in place with fixing clamps, see [Fixing clamps for top frame](#) [▶ page 38].
3. Hang the ear specula (pos. b) with the pointed side down in the spaces.
PLEASE NOTE: Ensure that the ear specula do not come into contact with each other.

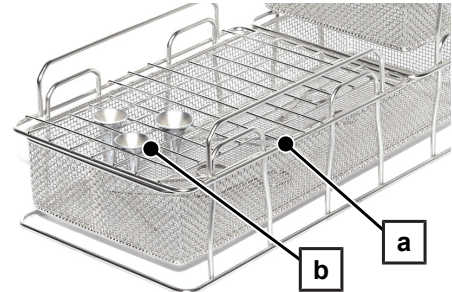

Flex basket 3 with top frame for ear specula Flex 2

Used with

- Flex basket 1, art. no. ME80010
- Flex basket 2, art. no. ME80020
- Flex basket 3, art. no. ME80030
- Fixing clamp for top frames, art. no. ME80420

Top frame for ear specula Flex 3

The top frame (art. no. ME80100) is used for reprocessing up to 96 ear specula in combination with a flex basket.

Application

You can use the top frame with flex baskets 1, 2 or 3 as you like, partially equipped or overlapping, e.g. one top frame on three flex baskets 1.

1. Place the top frame on flex basket 1, 2 or 3.
2. If required, fix the top frame in place with fixing clamps, see [Fixing clamps for top frame](#) [▶ page 38].
3. Hang the ear specula with the pointed side down in the spaces.
PLEASE NOTE: Ensure that the ear specula do not come into contact with each other.

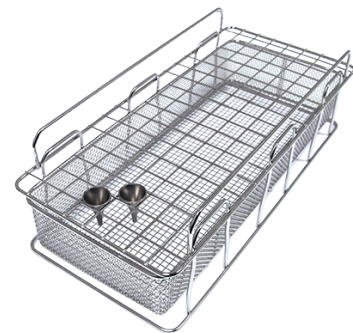

Used with

- Flex basket 1, art. no. ME80010
- Flex basket 2, art. no. ME80020
- Flex basket 3, art. no. ME80030
- Fixing clamp for top frames, art. no. ME80420

Top frame for nose specula Flex 1 incl. 2 fixing clamps

The top frame (art. no. ME80435) is used for reprocessing e.g. nose specula in combination with a flex basket.

Application

You can reprocess 9 to 12 nose specula per top frame, depending on the size.

1. Place the top frame on a flex basket and fix it with the fixing clamps, see [Fixing clamps for top frame](#) [▶ page 38].
2. Place the nose specula with the grip ends in the spaces so that the working ends are open.



Flex basket 1 with top frame for nose specula Flex 1

Used with

- Flex basket 1, art. no. ME80010
- Flex basket 2, art. no. ME80020
- Flex basket 3, art. no. ME80030
- Fixing clamp for top frames, art. no. ME80420

Fixing clamps for top frame

The fixing clamps (art. no. ME80420) are used to fix the top frames to the flex basket.

Application

1. Hook the brackets of the fixing clamp from the inside into the handle of the top frame.
2. Press the fixing clamp under the handle of the flex basket.



Fixing clamp hooked in

Used with

- Flex basket 1, art. no. ME80010
- Flex basket 2, art. no. ME80020
- Flex basket 3, art. no. ME80030
- Top frame for ear specula Flex 1 (mesh size 14 mm), art. no. ME80070
- Top frame for ear specula Flex 1 (mesh size 20 mm), art. no. ME80080
- Top frame for ear specula Flex 2 (mesh size 20 mm), art. no. ME80090
- Top frame for ear specula Flex 3 (mesh size 20 mm), art. no. ME80100
- Top frame for nose specula Flex 1 incl. 2 fixing clamps, art. no. ME80435

Instrument holder for flex baskets

The instrument holders (art. no. ME80395) are used for the ordered accommodation of instruments in the washing basket and provide a secure grip during the cleaning procedure. This avoids a situation in which the instruments slide around in the washing basket, thereby causing damage. This also improves the drying of the instruments. Hinged instruments can be held continuously open.

The scope of delivery includes 60 pieces.

Application



CAUTION

Danger of injury from sharp and pointed instruments.

The loading and unloading of pointed and sharp instruments can cause injuries if not handled properly.

- Wear suitable hand protection to avoid injuries during loading and unloading.

A minimum of two instrument holders are required per instrument. Multiple instrument holders may be required for hinged instruments



Flex basket 2 with instrument holders

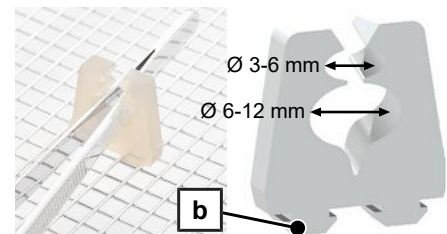

Inserting an instrument holder

1. If required, you can separate individual instrument holders from the latch (x 6 pcs., pos. a) by twisting or cutting them off and insert them separately in the washing basket.
2. Insert the instrument holders individually in the washing basket. Press the feet (pos. b) of the instrument holders individually into the meshes of the washing basket.
3. An instrument holder has two levels for instrument acceptance. Only fill a single level with an instrument at any one time.
 - Place instruments with a diameter of 3-6 mm in level 1 (top).
 - Place instruments with a diameter of 6-12 mm in level 2 (bottom).

- ▶ Replace instrument holders if they are visibly worn or damaged.

Used with

- Flex basket 1, art. no. ME80010
- Flex basket 2, art. no. ME80020
- Flex basket 3, art. no. ME80030
- Flex basket 6, art. no. ME80255

Sieve cassettes and inlays

Sieve cassette

The sieve cassette (art. no. ME00185)/sieve cassette incl. separation inlay and protrusion guard (art. no. ME80185) is used for reprocessing instrument sets or larger quantities of individual instruments in combination with the holder for sieve cassettes.

Application



CAUTION

Danger of injury from sharp and pointed instruments.

Pointed and sharp instruments may protrude through the sieve cassette meshing. This could result in serious injury.

- Use the protrusion guard for treating sharp and pointed instruments.

1. Place the instruments flat in the sieve cassette.
2. Close the sieve cassette with the lid.
3. **When using a holder:** Place the sieve cassette upright and with the closure facing upwards in the holder, see [Holders for MELAstore Tray and sieve cassettes](#) ► page 23].



Sieve cassette incl. separation inlay and protrusion guard



PLEASE NOTE

Avoid improper loading configurations that create unwashed areas (e.g. multiple stacking of instruments).

The cleaning result may be impaired.

Used with

- Holder for 3 MELAstore Trays/sieve cassettes, art. no. ME00180
- Holder for 4 MELAstore Trays/sieve cassettes, art. no. ME80040

Sieve cassette (art. no. ME00185) used with

- Protection inlay for sieve cassette, art. no. ME00189
- Protrusion guard for sieve cassette, art. no. ME00190
- Separation inlay for sieve cassette, art. no. ME00191

Protection inlay for sieve cassette

The protection inlay for the sieve cassette (art. no. ME00189) is a combination of a separation inlay with protrusion guard and provides security for the instruments in the sieve cassette. By using it, unwashed areas can be avoided. The protection inlay for the sieve cassette also prevents the protrusion of sharp instruments through the sieve cassette and thus protects the instruments with sensitive tips.

Application

1. Place the protection inlay lengthwise in the sieve cassette.
2. Distribute the instruments lengthwise on the three resulting segments.
3. Place the instruments in the protection inlay so that the pointed ends are inserted through the wire mesh.



Sieve cassette with protection inlay

Used with

- Sieve cassette, art. no. ME00185

Protrusion guard for sieve cassette

The protrusion guard (art. no. ME00190) prevents the protrusion of sharp instruments through the sieve cassette and thus protects the instruments with sensitive tips.

Application



CAUTION

Danger of injury from sharp and pointed instruments.

Pointed and sharp instruments may protrude through the sieve cassette meshing. This could result in serious injury.

- Use the protrusion guard for treating sharp and pointed instruments.

1. Insert the protrusion guard crosswise at one end of the sieve cassette.
2. Place the instruments in the sieve cassette so that the pointed ends point towards the protrusion guard.



Sieve cassette with protrusion guard

Used with

- Sieve cassette, art. no. ME00185

Separation inlay for sieve cassette

The separation inlay (art. no. ME00191) facilitates the stability of the instruments in the sieve cassette so as to avoid unwashed areas.

Application

1. Place the separation inlay lengthwise in the sieve cassette.
2. Distribute the instruments lengthwise on the three resulting segments.
 - ↳ It is intended that the instruments are able to move.

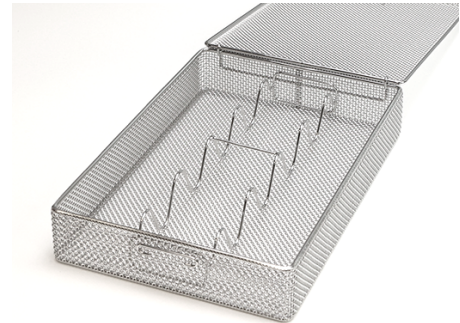

Sieve cassette with separation inlay

Used with

- Sieve cassette, art. no. ME00185

MELAstore Tray and silicone bars

MELAstore Tray 50, 100 and 200

MELAstore Tray 50 (art. no. ME01180), MELAstore Tray 100 (art. no. ME01181) and MELAstore Tray 200 (art. no. ME01182) are used for reprocessing larger quantities of individual instruments and can be stored in MELAstore Boxes. Comply with the application usage advice of the MELAstore Box 100 and 200.

Application

Note the following:

- Cheek retractors can only be reprocessed in the MELAstore Tray 100 or MELAstore Tray 200.
 - Do not reprocess hollow-body instruments in MELAstore Trays.
 - Observe the following instructions for using the MELAstore Trays in the insert rack, see [Holders](#) ► page 23].
1. Insert cheek retractors into MELAstore Tray 100/200 so that the handle fits through the recess in the lid when the tray is closed.
 2. Load the MELAstore Tray correctly for rinsing (e.g. hinged instruments opened, no loading over each other).
 3. Insert large area instruments in such a way as to prevent unwashed areas on other instruments.
 4. Place MELAstore Tray 50 and 100 in the holder for MELAstore Tray 50/100.
 5. Place MELAstore Tray 200 in the holder for 3 or 4 MELAstore Trays/ sieve cassettes.

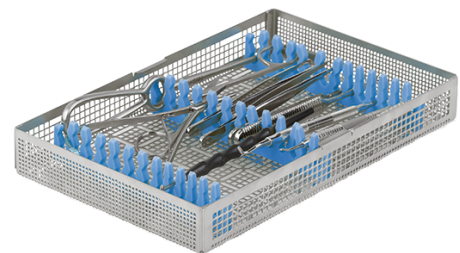

Loading MELAstore Tray 200

Used with

- Holder for 3 MELAstore Trays/sieve cassettes, art. no. ME00180
- MELAstore Box 100, art. no. ME01191
- MELAstore Box 200, art. no. ME01192
- Holder for identification plate MELAstore Tray, art. no. ME01197
- Holder for 4 MELAstore Trays/sieve cassettes, art. no. ME80040
- Holder for MELAstore Tray 50/100, art. no. ME80810

Silicone bars

The blue silicone bars are used for the ordered accommodation of instruments in the MELAstore Tray and provide a secure grip during the cleaning procedure. This also improves the drying of the instruments. Hinged instruments can be held continuously open.

Application



PLEASE NOTE

Use as few silicone bars as possible in a single MELAstore Tray to avoid unwashed areas and to improve the drying result. Note that the number and orientation of the silicone bars in the MELAstore Tray influence the cleaning result.

1. Insert the silicone bars individually in the MELAstore Tray.
 2. If necessary, you can cut off individual silicone bars and insert them separately.
 3. Press the feet into the recesses of the MELAstore Trays to fix the silicone bars.
 4. Only insert the silicone bar downholder in the lid. The downholder can be used to fix the instruments in place, especially in combination with the silicone bar with wave profile.
- ▶ Replace the silicone bars if they are visibly worn or damaged.

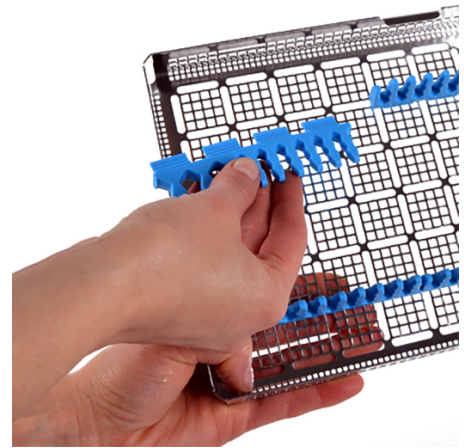

Inserting silicone bars in the MELAstore Tray

Used with

	Silicone bar for			Silicone bar	
	MELAstore Tray 50	MELAstore Tray 100	MELAstore Tray 200	with wave profile	downholder
MELAstore Tray 50, art. no. ME01180	X	X		X	X
MELAstore Tray 100, art. no. ME01181	X	X		X	X
MELAstore Tray 200, art. no. ME01182			X		

7 Accessories for interior cleaning



PLEASE NOTE

Check the hoses, connections and instruments before and after reprocessing to ensure that they are tight. Should a hose, connection or an instrument work loose, the instruments must be reprocessed again.

Accessories overview

Connectors and adapters for instruments

Injector nozzle
art. no. ME73860



see [Injector nozzle](#) [▶ page 52]

Clamp spring for injector nozzle
art. no. ME00196



see [Clamp spring for injector nozzle](#) [▶ page 53]

Rinse sleeve incl. 5 inserts
art. no. ME80260



see [Rinse sleeve incl. 5 inserts](#) [▶ page 53]

Set of insert rings for rinse sleeve, yellow (Ø 2-4 mm)
art. no. ME80290

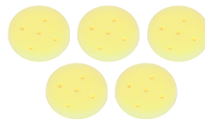

see [Rinse sleeve incl. 5 inserts](#) [▶ page 53]

Set of insert rings for rinse sleeve, green (Ø 4-6 mm)
art. no. ME80300



see [Rinse sleeve incl. 5 inserts](#) [▶ page 53]

Set of insert rings for rinse sleeve, blue (Ø 6-8 mm)
art. no. ME80310

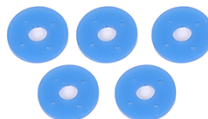

see [Rinse sleeve incl. 5 inserts](#) [▶ page 53]

Set of insert rings for rinse sleeve, grey (Ø 8-10 mm)
art. no. ME80320



see [Rinse sleeve incl. 5 inserts](#)
[▶ page 53]

Set of insert rings for rinse sleeve, red (Ø 10-11 mm)
art. no. ME80330



see [Rinse sleeve incl. 5 inserts](#)
[▶ page 53]

Luer adapter (male)
art. no. ME73880



see [Adapter \(male\) for Luer](#)
[▶ page 55]

Luer-Lock adapter (male)
art. no. ME74130



see [Adapter \(male\) for Luer-Lock](#)
[▶ page 55]

Luer/Luer-Lock adapter (female)
art. no. ME67250



see [Adapter \(female\) for Luer/Luer-Lock](#) [▶ page 56]

Adapter M3.0 x 0.5 mm, external thread
art. no. ME80750



see [Adapters for tips](#) [▶ page 56]

Adapter M3.6 x PH1.5 P0.5, internal thread
art. no. ME80751



see [Adapters for tips](#) [▶ page 56]

Adapter M3.0 x 0.35 mm, external thread
art. no. ME80752



see [Adapters for tips](#) [▶ page 56]

Adapter M3.0 x 0.35 mm, internal thread
art. no. ME80753



see [Adapters for tips](#) [▶ page 56]

Adapter M3.5 x 0.35 mm,
internal thread

art. no. ME80755



see [Adapters for tips](#) [▶ page 56]

Adapter M3.0 x 0.6 mm,
external thread

art. no. ME80756



see [Adapters for tips](#) [▶ page 56]

Adapter M3.0 x 0.6 mm,
internal thread

art. no. ME80757



see [Adapters for tips](#) [▶ page 56]

Adapter M3.5 x 0.6 mm,
internal thread

art. no. ME80760



see [Adapters for tips](#) [▶ page 56]

Adapter M3.5 x 0.6 mm,
external thread

art. no. ME80771



see [Adapters for tips](#) [▶ page 56]

Adapter M3.0 x 0.5 mm,
internal thread

art. no. ME80790



see [Adapters for tips](#) [▶ page 56]

Marking discs for adapter
(18 pcs.)

art. no. ME80769



see [Marking discs for adapters for tips](#) [▶ page 58]

Adapters for transmission instruments

Adapter for ISO connector
(INTRA)

art. no. ME80610



see [Adapter for ISO connector \(INTRA\)](#) [▶ page 59]

Adapter for turbines NSK
connector

art. no. ME80612



see [Adapter for turbines NSK connector \(Phatelus\)](#) [▶ page 60]

Adapter for EMS AIR-FLOW
Handy 3.0

art. no. ME80613



see [Adapter for EMS AIR-FLOW Handy 3.0](#) [▶ page 60]

Adapter for EMS AIR-FLOW
Prophylaxis Master

art. no. ME80614



see [Adapter for EMS AIR-FLOW Prophylaxis Master](#) [▶ page 61]

Adapter for Sirona T1 Classic

art. no. ME80620



see [Adapter for Sirona T1 Classic](#) [▶ page 61]

Adapter for contra angle heads
KaVo/BienAir

art. no. ME80630



see [Adapter for contra angle heads KaVo/BienAir](#) [▶ page 62]

Adapter for turbines with W&H
connector (Roto Quick)

art. no. ME80640



see [Adapter for turbines with W&H connector \(Roto Quick\)](#) [▶ page 63]

Adapter for turbines with
Sirona connector

art. no. ME80650



see [Adapter for turbines with Sirona connector](#) [▶ page 63]

Adapter for turbines with KaVo
connector (MULTIflex)

art. no. ME80660



see [Adapter for turbines with KaVo connector \(MULTIflex\)](#) [▶ page 64]

Filter disc housing incl.
ceramic filter disc

art. no. ME73905



see [Filter disc housing incl. ceramic filter disc](#) [▶ page 64]

Silicone insert for triple distributor, yellow (Ø 19 mm)

art. no. ME63503



see [Filter disc housing incl. ceramic filter disc](#) [▶ page 64]

Universal adapter incl. 3 inserts and ceramic filter disc

art. no. ME73904



see [Universal adapter incl. 3 inserts and ceramic filter disc](#) [▶ page 66]

Silicone insert, green (Ø 16 mm)

art. no. ME63500



see [Universal adapter incl. 3 inserts and ceramic filter disc](#) [▶ page 66]

Silicone insert, blue (Ø 20 mm)

art. no. ME63501

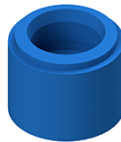

see [Universal adapter incl. 3 inserts and ceramic filter disc](#) [▶ page 66]

Silicone insert, white (Ø 22 mm)

art. no. ME63502



see [Universal adapter incl. 3 inserts and ceramic filter disc](#) [▶ page 66]

Instrument holder for universal adapter

art. no. ME22968

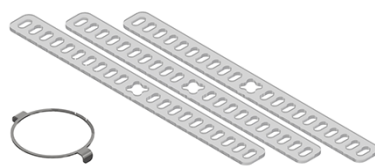

see [Instrument holder for universal adapter](#) [▶ page 67]

Distance sleeve

art. no. ME55120



see [Distance sleeve](#) [▶ page 68]

Adapter for external spray channels

art. no. ME74135



see [Adapter for external spray channels](#) [▶ page 68]

Double distributor
art. no. ME80200
(MELAtherm 10 only)



see [Double distributor](#)
▶ page 69]

Triple distributor incl. ceramic filter disc
art. no. ME73903



see [Triple distributor \(incl. ceramic filter disc\)](#) ▶ page 70]

Triple distributor
art. no. ME22611



see [Triple distributor](#) ▶ page 70]

Filter inserts

Ceramic filter disc (10 pcs.)
art. no. ME64375



see [Ceramic filter disc](#)
▶ page 72]

Metal filter disc
art. no. ME80350



see [Metal filter disc](#) ▶ page 72]

Upgrade kit injector rail incl. 2 plastic central filters
art. no. ME80480

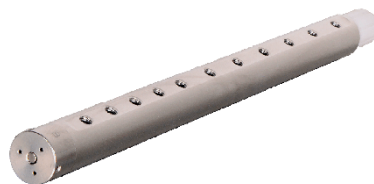

see [Plastic central filter](#)
▶ page 73]

Plastic central filter
art. no. ME80490



see [Plastic central filter](#)
▶ page 73]

Upgrade kit injector rail incl. Cleanfinity filter
art. no. ME84620



see [Converting to a new injector rail incl. Cleanfinity filter](#)
▶ page 78]

Cleanfinity filter
art. no. ME84630



see [Cleanfinity filter](#) [▶ page 74]

Cleaning brush for Cleanfinity filter
art. no. ME84640



see [Cleaning the Cleanfinity filter](#) [▶ page 74]

Sealing elements

Silicone closure cap, green
(10 pcs.)
art. no. ME89051



see [Silicone closure caps](#) [▶ page 79]

Silicone closure cap, blue
(10 pcs.)
art. no. ME89061



see [Silicone closure caps](#) [▶ page 79]

Silicone closure cap, white
(10 pcs.)
art. no. ME89071



see [Silicone closure caps](#) [▶ page 79]

Screw plug for injector rail and distributors
art. no. ME80140



see [Screw plug for injector rail and distributors](#) [▶ page 80]

Closure (male) for Luer-Lock
art. no. ME80170



see [Closure \(male\) for Luer-Lock](#) [▶ page 80]

Closure (female) for Luer/
Luer-Lock
art. no. ME80180



see [Closure \(female\) for Luer/Luer-Lock](#) [▶ page 81]

Hoses and hose connections

Hose connector (6 mm) with
external thread

art. no. ME80150



see [Hose connector \(6 mm\) with external thread](#) [▶ page 81]

Hose connector (6 mm) with
internal thread

art. no. ME80160



see [Hose connector \(6 mm\) with internal thread](#) [▶ page 82]

Silicone hose (10/6 mm), 2 m

art. no. ME80190



see [Silicone hose](#) [▶ page 82]

Silicone hose (10/6 mm) with
connectors, 0.5 m

art. no. ME80195



see [Silicone hose with connectors](#) [▶ page 83]

Connectors and adapters for instruments

Injector nozzle

The injector nozzle (art. no. ME73860) is used for reprocessing hollow instruments (e.g. dental surgical suction cannulas etc.).

Application with instruments

The following must be fulfilled or present:

- ✓ When using the triple distributor incl. ceramic filter disc (art. no. ME73903), remove the filter disc.
- 1. Screw the injector nozzle (pos. a) onto a connection of the injector rail (pos. c), the double distributor or the triple distributor (pos. b).
- 2. Tighten the injector nozzle by hand with a suitable open-end wrench.
- 3. Fit the hollow-body instruments on the injector nozzle and fix them with a clamp spring if necessary.

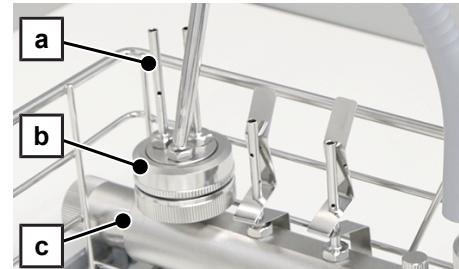

Connecting the injector nozzle

Application without instruments

- ▶ Close the injector nozzle with a suitable silicone closure cap if it is not equipped with an instrument. For more information on application, see [Verschlusselemente](#) ▶ page 79].



Injector nozzle with silicone closure cap

Used with

- Clamp spring for injector nozzle, art. no. ME00196
- Triple distributor, art. no. ME22611
- Triple distributor incl. ceramic filter disc (without filter disc), art. no. ME73903
- Only MELAtherm 10:
Double distributor, art. no. ME80200
- Silicone closure cap, green, art. no. ME89051

Clamp spring for injector nozzle

The clamp spring (art. no. ME00196) facilitates the fixing of light hollow-body instruments onto the injector nozzle so that this does not slip through the rinse pressure. The clamp spring is used exclusively with the injector nozzle.

Application

- ▶ Gently compress the clamp spring and slide it over the injector nozzle.

PLEASE NOTE: Do not use the clamp spring if the injector nozzle has been screwed onto the triple distributor incl. ceramic filter disc (art. no. ME73903).

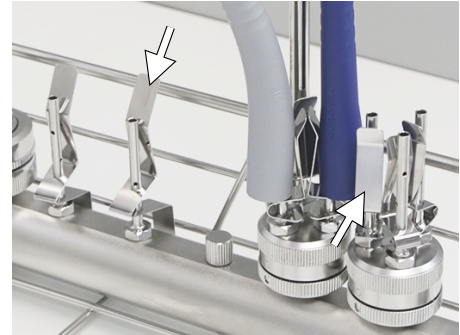

Injector nozzle with clamp spring

Used with

- Injector nozzle, art. no. ME73860

Rinse sleeve incl. 5 inserts

The rinse sleeve (art. no. ME80260) serves as an adapter for the reprocessing of hollow-body instruments with an outer diameter of 2-11 mm and a non-standard attachment. The correct insert rings are chosen for this purpose.

Application

1. Insert the suitable insert ring into the rinse sleeve.
2. Screw the rinse sleeve onto a connection on the injector rail or connect the rinse sleeve (pos. a) to the injector rail via a silicone hose (art. no. ME80195).
3. If necessary, place everything in a flex basket.
4. Insert the instrument into the rinse sleeve with the shaft side first.

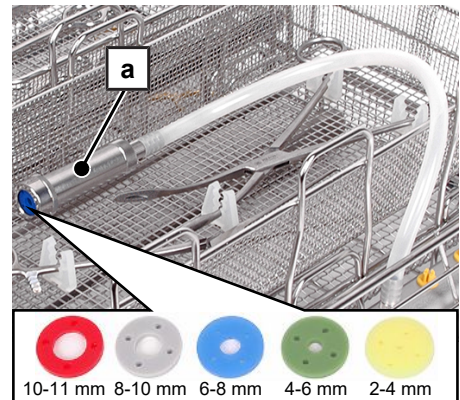

Connection example, rinse sleeve

Rinse sleeve with rinse sleeve extension

The rinse sleeve comes with a rinse sleeve extension. This is used for reprocessing long hollow-body instruments without a defined connection option (e.g. rigid endoscopes and magnetostrictive attachments).

Routine check

- ▶ Check the rinse sleeve extension regularly for soiling and clean if necessary.

Application**WARNING****Risk of contamination due to reduced cleaning performance**

The reprocessing of hollow-body instruments with an inside diameter of ≤ 0.8 mm requires a fine filter of the liquor.

- Only insert the rinse sleeve together with the filter disc housing or the central filter.

1. Screw the rinse sleeve extension (pos. b) between the rinse sleeve (pos. c) and the shaft (pos. a) of the rinse sleeve.
2. Insert the instrument into the receptacle of the rinse sleeve extension.

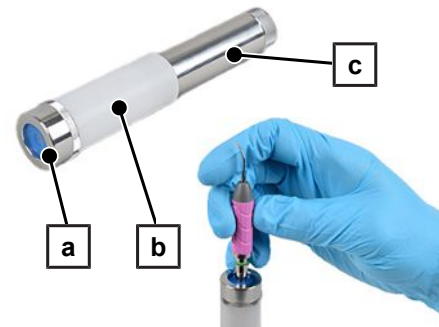

Rinse sleeve with rinse sleeve extension

The "water inlet" opening of the instrument must be inside the rinse sleeve extension.

The "water outlet" opening of the instrument must be outside the rinse sleeve extension.

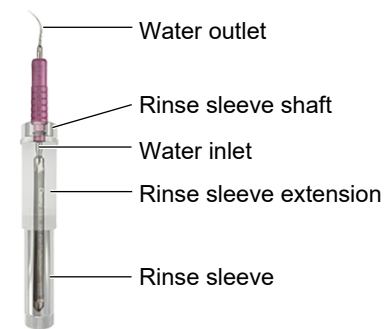
**Used with**

- Filter disc housing incl. ceramic filter disc, art. no. ME73905
- Silicone hose (10/6 mm) with connectors, 0.5 m, art. no. ME80195
- Basis basket with injector rail incl. 2 plastic central filters, art. no. ME80440
- Basis basket with injector rail incl. Cleanfinity filter, art. no. ME84610

Adapter (male) for Luer

The adapter (male) for Luer (art. no. ME73880) is used for reprocessing instruments/cannulas with a Luer connection (female).

Application

1. Screw the adapter onto a connection of the injector rail, the filter disc housing, the double distributor or the triple distributor.
2. Tighten the adapter by hand with a suitable open-end wrench.
3. Plug the instrument firmly onto the adapter while rotating.
4. Since the instruments are only plugged onto the adapters and not screwed, check that the instruments are firmly seated before and after reprocessing.

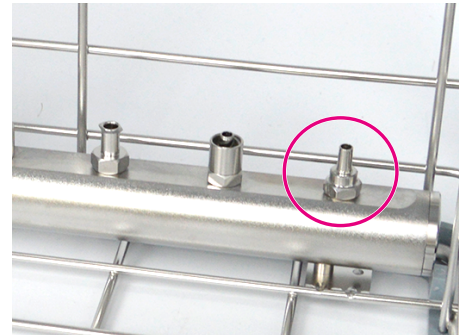

Connection example on injector rail

Used with

- Triple distributor, art. no. ME22611
- Triple distributor incl. ceramic filter disc, art. no. ME73903
- Filter disc housing incl. ceramic filter disc, art. no. ME73905
- Closure (female) for Luer/Luer-Lock , art. no. ME80180
- Only MELAtherm 10:
Double distributor, art. no. ME80200

Adapter (male) for Luer-Lock

The adapter (male) for Luer-Lock (art. no. ME74130) is used for reprocessing instruments/cannulas with a Luer-Lock connection (female).

Application

1. Screw the adapter onto a connection of the injector rail, the filter disc housing, the double distributor or the triple distributor.
2. Tighten the adapter by hand with a suitable open-end wrench.
3. Screw the instrument hand-tight onto the adapter.

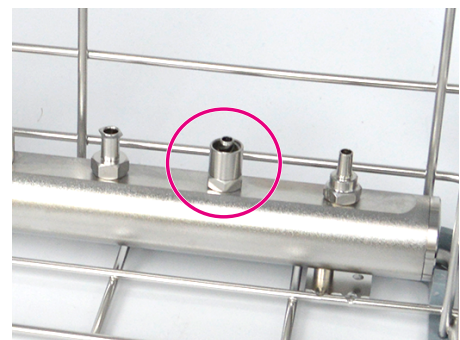

Connection example on injector rail

Used with

- Triple distributor, art. no. ME22611
- Triple distributor incl. ceramic filter disc, art. no. ME73903
- Filter disc housing incl. ceramic filter disc, art. no. ME73905
- Closure (male) for Luer-Lock, art. no. ME80170
- Only MELAtherm 10:
Double distributor, art. no. ME80200

Adapter (female) for Luer/Luer-Lock

The adapter (female) for Luer/Luer-Lock (art. no. ME67250) is used for reprocessing instruments/cannulas with a Luer / Luer-Lock connection (male).

Application

1. Screw the adapter onto a connection of the injector rail, the filter disc housing, the double distributor or the triple distributor.
2. Tighten the adapter by hand with a suitable open-end wrench.
3. Plug the instrument firmly onto the adapter while rotating.
4. Since the instruments are only plugged onto the adapters and not screwed, check that the instruments are firmly seated before and after reprocessing.

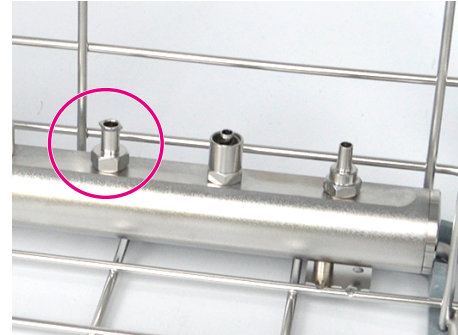

Connection example on injector rail

Used with







- Triple distributor, art. no. ME22611
- Triple distributor incl. ceramic filter disc, art. no. ME73903
- Filter disc housing incl. ceramic filter disc, art. no. ME73905
- Closure (female) for Luer/Luer-Lock , art. no. ME80180
- Only MELAtherm 10:
Double distributor, art. no. ME80200





Adapters for tips

The adapters are used to clean the interiors of ultrasonic and scaler tips.

Compatibility

A constantly updated overview of the compatibility of adapters for tips can be found on the MELAG website. Only the instruments listed on the website and those listed below are compatible.

Adapters		Compatible with
M3.0 x 0.5 mm, external thread art. no. ME80750		KaVo SONOsoft, PiezoLUX EMS Piezon/Piezon LED W&H Piezo Scaler: Tigon, Tigon+, Pyon 2 Surgery: Piezomed Komet PiezoLine EM1, PiezoLine KA1, PiezoLine KA2 NSK Varios EMS Mectron Multipiezo, PiezoSmart, Micropiezo, Compact Piezo Hu-Friedy Piezo E-Series (EMS)
M3.6 x PH1.5 P0.5, internal thread art. no. ME80751		KaVo SONICflex quick 2008
M3.0 x 0.35 mm, external thread art. no. ME80752		KaVo PiezoLED, PiezoSoft
M3.0 x 0.35 mm, internal thread art. no. ME80753		KaVo PiezoLED, PiezoSoft
M3.5 x 0.35 mm, internal thread art. no. ME80755		Planmeca LM ProPower
M3.0 x 0.6 mm, external thread art. no. ME80756		Acteon (Satelec) Newtron, Suprasson NSK Varios NSK, Satelec Hu-Friedy Piezo S-Series (NSK, Satelec, Hu-Friedy) Ultradent Newtron

Adapters		Compatible with
M3.0 x 0.6 mm, internal thread art. no. ME80757		Acteon (Satelec) Newtron, Suprasson NSK Varios NSK, Satelec
M3.5 x 0.6 mm, internal thread art. no. ME80760		Sirona SIROSON, SIROSONIC, PerioSonic Komet PiezoLineS11 Dürr Vector Scaler
M3.5 x 0.6 mm, external thread art. no. ME80771		Sirona SIROSON, SIROSONIC, PerioSonic
M3.0 x 0.5 mm, internal thread art. no. ME80790		KaVo SONICflex 2000, 2003 EMS Piezon/Piezon LED Sirona SIROAIR L W&H air scaler: Proxeo, Synea, Alegra Komet SonicLine: Komet SF1LM NSK air scaler: Ti-Max S970, AS2000

Application with instruments



WARNING

Danger of contamination

Using tips with an external coolant connection reduces the cleaning performance.

- Connect additional adapters for external spray channels, see [Adapter for external spray channels](#) [▶ page 68].
- Comply with the specifications from the instrument manufacturer.

Note the following:

- Reprocessing with a torque wrench connected is possible, as far as this has been approved by the manufacturer for automatic reprocessing.
- Ensure that you use an adapter with a compatible thread to prevent damage to the instrument.
- Comply with the instrument manufacturer’s instructions regarding reprocessing in a washer-disinfector.

1. Screw the adapter onto a connection of the injector basket Flex 1, the filter disc housing (injector rail without central filter) or directly onto the injector rail with central filter.
2. Tighten the adapter by hand with a suitable open-end wrench.
3. Use the torque wrench from the instrument manufacturer to screw the tips on and off.



Connection example with injector basket Flex 1

Application without instruments

- ▶ Close adapters with a suitable silicone closure cap if they are not fitted with an instrument. For more information on application, see [Sealing elements](#) [▶ page 79].

Used with

- Filter disc housing incl. ceramic filter disc, art. no. ME73905
- Basis basket with injector rail incl. 2 plastic central filters, art. no. ME80440
- Injector basket Flex 1, art. no. ME80740
- Basis basket with injector rail incl. Cleanfinity filter, art. no. ME84610
- Silicone closure cap, green, art. no. ME89051

Marking discs for adapters for tips

The marking discs (art. no. ME80769) are used to visually distinguish the adapters for tips. This prevents instruments from being accidentally screwed onto the wrong adapters and possibly damaging the thread.

The set includes 6 green, blue and yellow marking discs.

Application

1. Unscrew the adapter for tips from the injector rail.
2. Slide the marking disc over the large thread of the adapter.
3. Screw the adapter for tips together with the marking disc back onto the injector rail.



Injector basket Flex 1 with marking discs

Used with

- Adapters for tips, art. no. ME80750, ME80751, ME80752, ME80753, ME80755, ME80756, ME80757, ME80760, ME80771, ME80790

Adapters for transmission instruments







NOTICE

Transmission instruments can be damaged if filters are not used.

- Reprocess the transmission instruments only when suitable filters are installed.

Selection aid for the use of adapters for transmission instrument

Transmission instruments		Adapters for transmission instruments	
Handpieces and contra angles	Intracoupling	Adapter for ISO connector (INTRA) art. no. ME80610	
	EMS AIR-FLOW	Adapter for EMS AIR-FLOW Handy 3.0 art. no. ME80613	
		Adapter for EMS AIR-FLOW Prophylaxis Master art. no. ME80614	
	Sirona T1 Classic	Adapter for Sirona T1 Classic art. no. ME80620	
	Heads of the KaVo contra angles	Adapter for contra angle heads KaVo/BienAir art. no. ME80630	

Transmission instruments		Adapters for transmission instruments	
Turbines	NSK Phatelus	Adapter for turbines NSK connector art. no. ME80612	
	W&H ROTO QUICK	Adapter for turbines with W&H connector (Roto Quick) art. no. ME80640	
	Sirona quick coupling R/F	Adapter for turbines with Sirona connector art. no. ME80650	
	KaVo Multiflex LUX	Adapter for turbines with KaVo connector (MULTIflex) art. no. ME80660	
Hollow-body instruments in general	without a specific connection	Universal adapter incl. 3 inserts and ceramic filter disc art. no. ME73904	
	<ul style="list-style-type: none"> ▪ For example, for reprocessing transmission instruments, attachments of powder jet devices, etc. ▪ Connection possible with and without filter disc. ▪ Inserts: green (Ø 16 mm), blue (Ø 20 mm), white (Ø 22 mm) 		

Adapter for ISO connector (INTRA)

The adapter (art. no. ME80610) is used to accommodate mechanically driven transmission instruments (e.g. handpieces, contra angles). Contra angles with a short ISO connection (e.g. Sirona T1/T2-Line, W&H Synea Vision Short Edition, NSK nlx nano etc.) can also be connected.

Application with instruments

1. Screw the adapter onto a connection of the injector rail with central filter or a filter disc housing (injector rail without central filter).
2. Tighten the adapter by hand with a suitable open-end wrench.
3. Plug the instrument onto the adapter until it clicks into place.

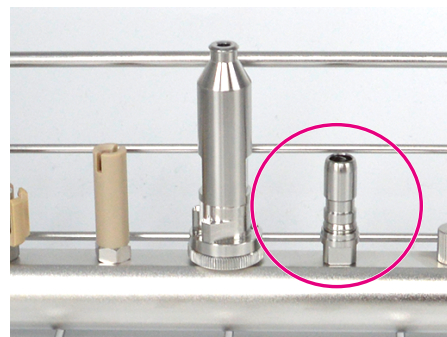

Connection example on injector rail

Application without instruments

- ▶ Close adapters with a suitable silicone closure cap if they are not fitted with an instrument. For more information on application, see [Sealing elements](#) [▶ page 79].

Used with

- Filter disc housing incl. ceramic filter disc, art. no. ME73905
- Basis basket with injector rail incl. 2 plastic central filters, art. no. ME80440
- Basis basket with injector rail incl. Cleanfinity filter, art. no. ME84610
- MELAtherm 10 Evolution only:
Injector basket Flex 1, art. no. ME80740
- Silicone closure cap, white, art. no. ME89071

Adapter for turbines NSK connector (Phatelus)

The adapter (art. no. ME80612) is used to accommodate turbines with NSK Phatelus connection.

Application with instruments

1. Screw the adapter onto a connection of the injector rail with central filter or a filter disc housing (injector rail without central filter).
2. Tighten the adapter by hand.
3. Plug the instrument onto the adapter until it clicks into place.

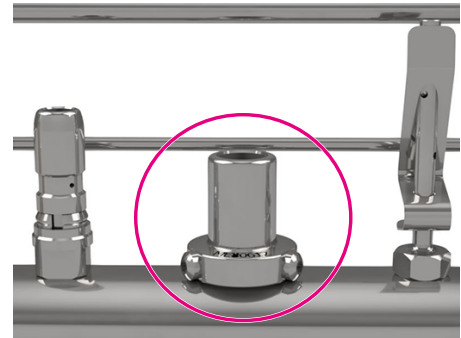

Connection example on injector rail

Application without instruments

- ▶ Close adapters with a suitable silicone closure cap if they are not fitted with an instrument. For more information on application, see [Sealing elements](#) [▶ page 79].

Used with

- Filter disc housing incl. ceramic filter disc, art. no. ME73905
- Basis basket with injector rail incl. 2 plastic central filters, art. no. ME80440
- Basis basket with injector rail incl. Cleanfinity filter, art. no. ME84610
- MELAtherm 10 Evolution only:
Injector basket Flex 1, art. no. ME80740
- Silicone closure cap, white, art. no. ME89071

Adapter for EMS AIR-FLOW Handy 3.0

The adapter (art. no. ME80613) is used to accommodate the handpieces EL-540, EL-542 and EL-545 for EMS Air-Flow Handy 3.0 powder jet devices.

Application with instruments

1. Screw the adapter onto a connection of the injector rail with central filter or a filter disc housing (injector rail without central filter).
2. Tighten the adapter by hand with a suitable open-end wrench.
3. Plug the instrument onto the adapter until it clicks into place.

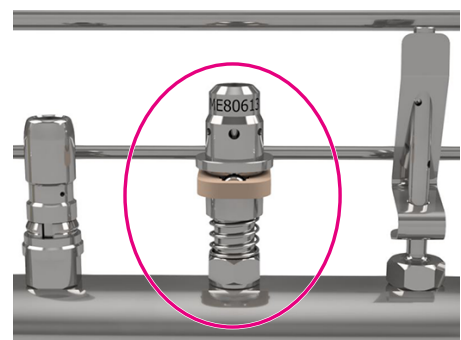

Connection example on injector rail

Application without instruments

- ▶ Close adapters with a suitable silicone closure cap if they are not fitted with an instrument. For more information on application, see [Sealing elements](#) [▶ page 79].

Used with

- Filter disc housing incl. ceramic filter disc, art. no. ME73905
- Basis basket with injector rail incl. 2 plastic central filters, art. no. ME80440

- Basis basket with injector rail incl. Cleanfinity filter, art. no. ME84610
- MELAtherm 10 Evolution only:
Injector basket Flex 1, art. no. ME80740
- Silicone closure cap, white, art. no. ME89071

Adapter for EMS AIR-FLOW Prophylaxis Master

The adapter (art. no. ME80614) is used to accommodate the handpieces EL-308 for EMS Air-Flow Prophylaxis Master powder jet devices.

Application with instruments

1. Screw the adapter onto a connection of the injector rail with central filter or a filter disc housing (injector rail without central filter).
2. Tighten the adapter by hand with a suitable open-end wrench.
3. Plug the instrument onto the adapter until it clicks into place.

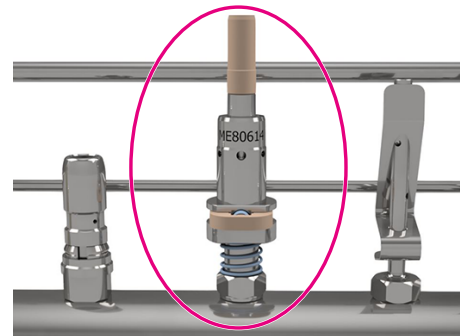

Connection example on injector rail

Application without instruments

- ▶ Close adapters with a suitable silicone closure cap if they are not fitted with an instrument. For more information on application, see [Sealing elements](#) [▶ page 79].

Used with

- Filter disc housing incl. ceramic filter disc, art. no. ME73905
- Basis basket with injector rail incl. 2 plastic central filters, art. no. ME80440
- Basis basket with injector rail incl. Cleanfinity filter, art. no. ME84610
- MELAtherm 10 Evolution only:
Injector basket Flex 1, art. no. ME80740
- Silicone closure cap, white, art. no. ME89071

Adapter for Sirona T1 Classic

The adapter (art. no. ME80620) is used to accommodate handpieces and contra angles of the Classic series from Sirona.

Application with instruments

1. Screw the adapter onto a connection of the injector rail with central filter or a filter disc housing (injector rail without central filter).
2. Tighten the adapter by hand with a suitable open-end wrench.
3. Plug the instrument onto the adapter until it clicks into place.

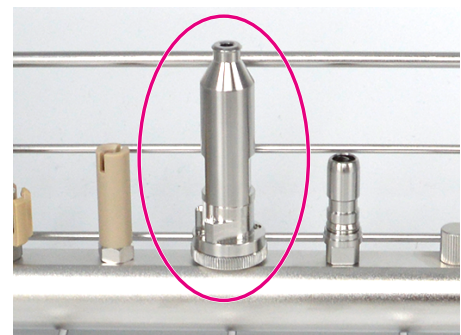

Connection example on injector rail

Application without instruments

- ▶ Close adapters with a suitable silicone closure cap if they are not fitted with an instrument. For more information on application, see [Sealing elements](#) [▶ page 79].

Used with

- Filter disc housing incl. ceramic filter disc, art. no. ME73905
- Basis basket with injector rail incl. 2 plastic central filters, art. no. ME80440
- MELAtherm 10 Evolution only:
Injector basket Flex 1, art. no. ME80740
- Basis basket with injector rail incl. Cleanfinity filter, art. no. ME84610
- Silicone closure cap, blue, art. no. ME89061

Adapter for contra angle heads KaVo/BienAir

The adapter (art. no. ME80630) is used to accommodate the removable heads of contra angles made by KaVo and Bien-Air.

Application with instruments

1. Screw the adapter onto a connection of the injector rail with central filter, a triple distributor or a filter disc housing (injector rail without central filter).
2. Tighten the adapter by hand with a suitable open-end wrench.
3. Plug the instrument onto the adapter until it clicks into place.

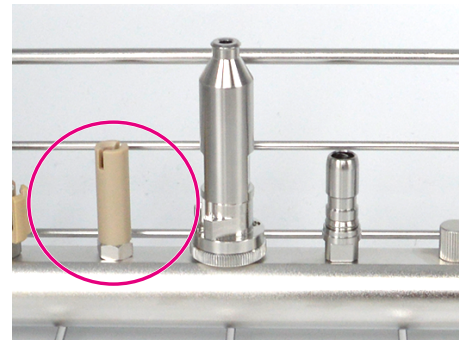

Connection example on injector rail

Application without instruments

- ▶ Close adapters with a suitable silicone closure cap if they are not fitted with an instrument. For more information on application, see [Sealing elements](#) [▶ page 79].

Used with

- Triple distributor incl. ceramic filter disc, art. no. ME73903
- Filter disc housing incl. ceramic filter disc, art. no. ME73905
- Basis basket with injector rail incl. 2 plastic central filters, art. no. ME80440
- Basis basket with injector rail incl. Cleanfinity filter, art. no. ME84610
- MELAtherm 10 Evolution only:
Injector basket Flex 1, art. no. ME80740
- Silicone closure cap, white, art. no. ME89071

Adapter for turbines with W&H connector (Roto Quick)

The adapter (art. no. ME80640) is used to accommodate W&H turbines.

Application with instruments

1. Screw the adapter onto a connection of the injector rail with central filter or a filter disc housing (injector rail without central filter).
2. Tighten the adapter by hand with a suitable open-end wrench.
3. Plug the instrument onto the adapter until it clicks into place.

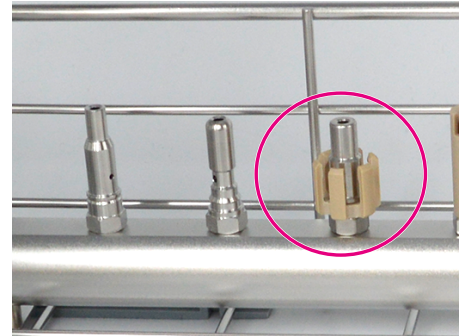

Connection example on injector rail

Application without instruments

- ▶ Close adapters with a suitable silicone closure cap if they are not fitted with an instrument. For more information on application, see [Sealing elements](#) [▶ page 79].

Used with

- Filter disc housing incl. ceramic filter disc, art. no. ME73905
- Basis basket with injector rail incl. 2 plastic central filters, art. no. ME80440
- MELAtherm 10 Evolution only:
Injector basket Flex 1, art. no. ME80740
- Basis basket with injector rail incl. Cleanfinity filter, art. no. ME84610
- Silicone closure cap, blue, art. no. ME89061

Adapter for turbines with Sirona connector

The adapter (art. no. ME80650) is suitable for all turbines with Sirona quick coupling R/F.

Application with instruments

1. Screw the adapter onto a connection of the injector rail with central filter or a filter disc housing (injector rail without central filter).
2. Tighten the adapter by hand with a suitable open-end wrench.
3. Plug the instrument onto the adapter until it clicks into place.

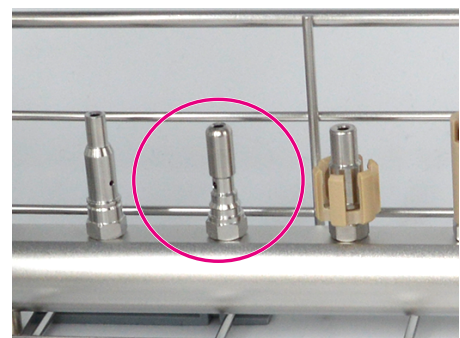

Connection example on injector rail

Application without instruments

- ▶ Close adapters with a suitable silicone closure cap if they are not fitted with an instrument. For more information on application, see [Sealing elements](#) [▶ page 79].

Used with

- Filter disc housing incl. ceramic filter disc, art. no. ME73905
- Basis basket with injector rail incl. 2 plastic central filters, art. no. ME80440

- MELAtherm 10 Evolution only:
Injector basket Flex 1, art. no. ME80740
- Basis basket with injector rail incl. Cleanfinity filter, art. no. ME84610
- Silicone closure cap, blue, art. no. ME89061

Adapter for turbines with KaVo connector (MULTiflex)

The adapter (art. no. ME80660) is used to accommodate instruments with a MULTiflex connection.

Application with instruments

1. Screw the adapter onto a connection of the injector rail with central filter or a filter disc housing (injector rail without central filter).
2. Tighten the adapter by hand with a suitable open-end wrench.
3. Plug the instrument onto the adapter until it clicks into place.

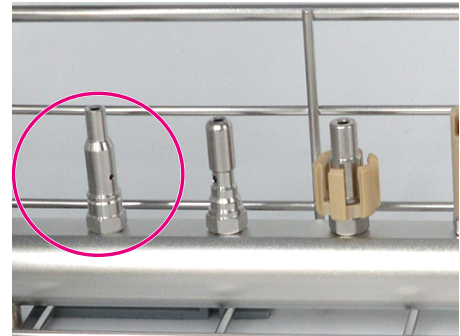

Connection example on injector rail

Application without instruments

- ▶ Close adapters with a suitable silicone closure cap if they are not fitted with an instrument. For more information on application, see [Sealing elements](#) [▶ page 79].

Used with

- Filter disc housing incl. ceramic filter disc, art. no. ME73905
- Basis basket with injector rail incl. 2 plastic central filters, art. no. ME80440
- MELAtherm 10 Evolution only:
Injector basket Flex 1, art. no. ME80740
- Basis basket with injector rail incl. Cleanfinity filter, art. no. ME84610
- Silicone closure cap, blue, art. no. ME89061

Filter disc housing incl. ceramic filter disc

The filter disc housing (art. no. ME73905) is used for the filtration of a single connection on the injector rail, as long as no central filter is used in the injector rail. Both the re-usable metal filter disc (art. no. ME80350) and the ceramic filter disc (art. no. ME64375) can be used.

Application



WARNING

Risk of contamination due to reduced cleaning performance

If the filter housing is not closed correctly or the connection on the injector rail is not correct, then the filter effect can be impaired.

- Always check that the filter housing is sealed fully and is connected correctly to the injector rail.

Note the following:

- The reprocessing of hollow-body instruments with an inside diameter of ≤ 0.8 mm requires a fine filter of the liquor.
- Do not combine the filter disc housing with other filter elements. Only connect the filter disc housing on the injector rail without the central filter.

All available adapters can be screwed onto the filter disc housing. Use of the injector basket Flex 1 and the injector rail without a central filter requires two filter disc housings to connect both connection hoses.

1. Screw the filter disc housing onto a connection on the injector rail.
2. Tighten the filter disc housing by hand.



Connection example with injector basket Flex 1

Inserting/replacing the ceramic/metal filter disc

The filter disc must be replaced at regular intervals. For more information, see [Filter inserts](#) [▶ page 72].

1. Rinse the re-usable metal filter disc (pos. d) under running water before initial use.
Rinse the new ceramic filter disc (pos. c) briefly under running water.
2. Remove any dirt particles from the adapter, preferably with compressed air.
3. Insert the filter disc in the yellow silicone insert (pos. b, art. no. ME63503).
4. Insert the yellow silicone insert in the lower section (pos. e) of the filter disc housing with the filter disc pointing downwards.
PLEASE NOTE: Insert the silicone insert with the re-usable metal filter disc in the housing. The printed side of the metal filter disc **must always point downwards**.
5. Place the upper section (pos. a) of the filter disc housing on the lower section (pos. e) and turn the bayonet cap to its fullest extent (the markings lie over each other).

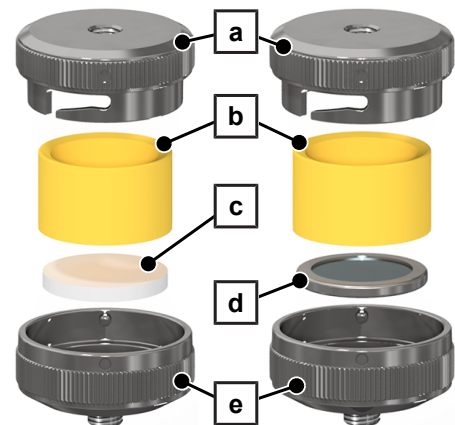

Used with

- Basis basket with injector rail incl. 11 injector nozzles and clamp springs, art. no. ME00197
- Basis basket with injector rail, art. no. ME00200
- Silicone insert for triple distributor, yellow (Ø 19 mm), art. no. ME63503
- Ceramic filter disc, art. no. ME64375
- Luer/Luer-Lock adapter (female), art. no. ME67250
- Luer adapter (male), art. no. ME73880
- Luer-Lock adapter (male), art. no. ME74130
- Hose connector (6 mm) with external thread, art. no. ME80150
- Silicone hose (10/6 mm) with connectors, 0.5 m, art. no. ME80195
- Rinse sleeve incl. 5 inserts, art. no. ME80260
- Metal filter disc, art. no. ME80350
- Adapter for ISO connector (INTRA), art. no. ME80610
- Adapter for turbines NSK connector, art. no. ME80612
- Adapter for EMS AIR-FLOW Handy 3.0, art. no. ME80613
- Adapter for EMS AIR-FLOW Prophylaxis Master, art. no. ME80614
- Adapter for Sirona T1 Classic, art. no. ME80620
- Adapter for contra angle heads KaVo/BienAir, art. no. ME80630
- Adapter for turbines with W&H connector (Roto Quick), art. no. ME80640

- Adapter for turbines with Sirona connector, art. no. ME80650
- Adapter for turbines with KaVo connector (MULTIflex), art. no. ME80660
- Injector basket Flex 1, art. no. ME80740
- Adapters for tips, art. no. ME80750, ME80751, ME80752, ME80753, ME80755, ME80756, ME80757, ME80760, ME80771, ME80790

Universal adapter incl. 3 inserts and ceramic filter disc

The universal adapter (art. no. ME73904) is used to accommodate hollow-body instruments without a defined connection (e.g. attachments for the powder jet device)

The universal adapter can accommodate a filter disc. Take this into account when reprocessing instruments with an inside diameter ≤ 0.8 mm. Both the re-usable metal filter disc (art. no. ME80350) and the ceramic filter disc (art. no. ME64375) can be used.

Application

Note the following:

- Do not combine several filter elements to avoid reduced rinse pressure.
- Hollow-body instruments with an interior diameter ≤ 0.8 mm require filter elements.
- When using the basis basket with injector rail and central filter, the filter disc must be removed from the universal adapter.
- Comply with the regular replacement intervals for the filter discs, see [Filter inserts](#) [▶ page 72].

1. Select the silicone insert in accordance with the external diameter of the hollow-body instruments to be reprocessed and insert them in the universal adapter.
2. Screw the adapter onto a connection on the injector rail.
3. Tighten the adapter by hand.
4. Insert the hollow-body instruments into the universal adapter with the shaft facing downwards.

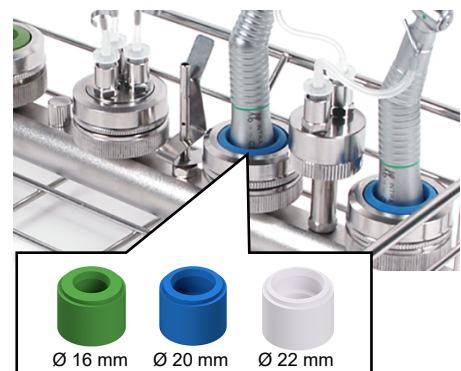

Loading example, universal adapter

When using distance sleeves (art. no. ME55120) multiple universal adapters can be screwed onto the injector rail next to each other.

Up to 11 universal adapters with distance sleeve fit on the injector rail **without** a central filter.

Up to 9 universal adapters with distance sleeve fit on the injector rail **with** a central filter.



Injector with universal adapter

Inserting/replacing the ceramic/metal filter disc

1. Rinse the re-usable metal filter disc (pos. d) under running water before initial use.
Rinse the new ceramic filter disc (pos. c) briefly under running water.
2. Insert the filter disc in the green, blue or white silicone insert (pos. b).
3. Insert the green, blue or white silicone insert in the lower section (pos. e) of the universal adapter with the filter disc pointing downwards.
PLEASE NOTE: Insert the silicone insert with the re-usable metal filter disc in the housing. The printed side of the metal filter disc **must always point downwards**.
4. Place the upper section (pos. a) of the universal adapter on the lower section and screw them together hand-tight.

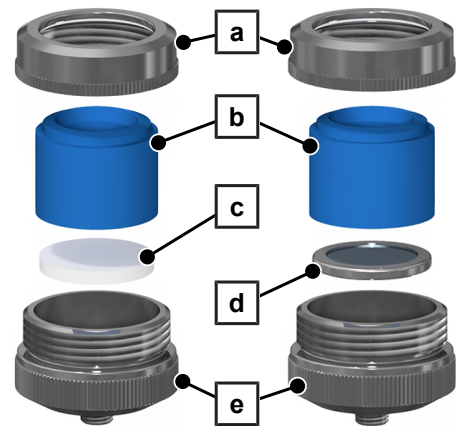

Used with

- Basis basket with injector rail incl. 11 injector nozzles and clamp springs, art. no. ME00197
- Basis basket with injector rail, art. no. ME00200
- Distance sleeve, art. no. ME55120
- Silicone insert, green (Ø 16 mm), art. no. ME63500
- Silicone insert, blue (Ø 20 mm), art. no. ME63501
- Silicone insert, white (Ø 22 mm), art. no. ME63502
- Ceramic filter disc, art. no. ME64375
- Metal filter disc, art. no. ME80350
- Basis basket with injector rail incl. 2 plastic central filters, art. no. ME80440
- MELAtherm 10 Evolution only:
Injector basket Flex 1, art. no. ME80740
- Basis basket with injector rail incl. Cleanfinity filter, art. no. ME84610

Instrument holder for universal adapter

The instrument holder for universal adapter (art. no. ME22968) facilitates the fixing of the instrument in the universal adapter during reprocessing.

The scope of delivery includes a retaining ring and three silicone strips.

Application

1. Unscrew the upper section of the universal adapter.
2. Place the retaining ring on the lower section of the universal adapter. The hooks must point downwards.
3. Place the upper section of the universal adapter on the lower section and screw them together hand tight.
4. Screw the adapter onto a connection on the injector rail.
5. Tighten the adapter by hand.

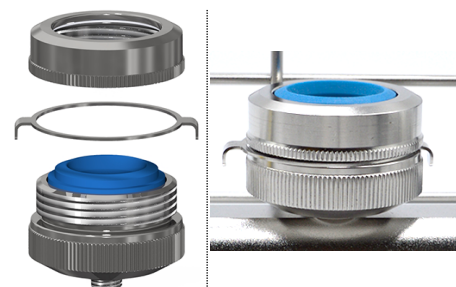

Universal adapter incl. retaining ring

6. Plug the hollow-body instrument in the universal adapter with the shaft facing downwards.
7. Fit the silicone strip loosely on the instrument and tense the strip with the aid of the hooks on the retaining ring.



Universal adapter incl. retaining ring and silicone strip

Used with

- Universal adapter incl. 3 inserts and ceramic filter disc, art. no. ME73904

Distance sleeve

The distance sleeve (art. no. ME55120) is used to maximise the use of the injector rail when using filter disc housings, universal adapters or triple distributors.

Application

1. Screw the distance sleeve onto a connection on the injector rail.
2. Tighten the distance sleeve by hand.
3. Screw the desired adapter onto the distance sleeve.

Up to 11 universal adapters with distance sleeve fit on the injector rail **without** a central filter.

Up to 9 universal adapters with distance sleeve fit on the injector rail **with** a central filter.

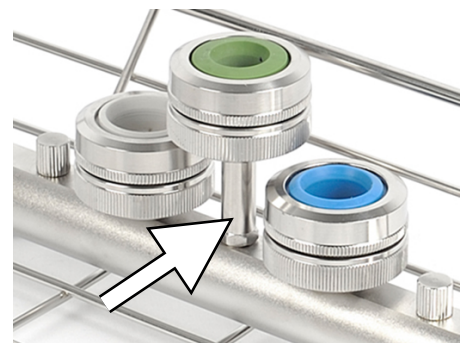

Distance sleeve with universal adapter

Used with

- Triple distributor incl. ceramic filter disc, art. no. ME73903
- Universal adapter incl. 3 inserts and ceramic filter disc, art. no. ME73904
- Filter disc housing incl. ceramic filter disc, art. no. ME73905

Adapter for external spray channels

The adapter (art. no. ME74135) is used to rinse exterior (spray) channels of transmission instruments and other non-standardised hollow-body instruments with a small external diameter.

Application



WARNING

Risk of contamination due to reduced cleaning performance

Loosely attached silicone hoses can slip from the channels during the program run.

- Check the instruments after the program run to verify the position of the silicone hose.
- If silicone hoses have slipped off, the instrument concerned must be reprocessed again.

1. Screw the adapter for external spray channels onto an injector rail connection with central filter, a double distributor, a triple distributor or a filter disc housing (injector rail without central filter).
2. Tighten the adapter by hand with a suitable open-end wrench.
3. Cut the silicone hose included in the delivery to the required length so that it neither sags and forms loops nor is too tight.
4. Put the free end of the silicone hose on the (spray) channel to be rinsed.
PLEASE NOTE: Make sure that you connect the silicone hose to the inlet side of the spray channel, i.e. in the direction of flow.

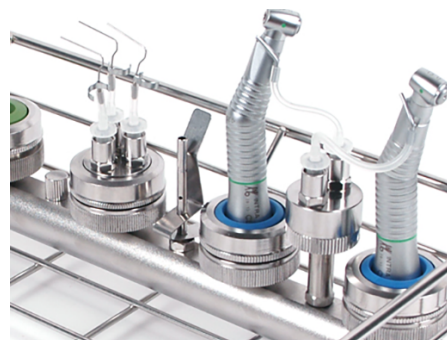

Connection example, adapter for external spray channels

Used with

- Triple distributor, art. no. ME22611
- Triple distributor incl. ceramic filter disc, art. no. ME73903
- Filter disc housing incl. ceramic filter disc, art. no. ME73905
- Only MELAtherm 10:
 Double distributor, art. no. ME80200
- Basis basket with injector rail incl. 2 plastic central filters, art. no. ME80440
- Basis basket with injector rail incl. Cleanfinity filter, art. no. ME84610

Double distributor

(MELAtherm 10 only)

The double distributor (art. no. ME80200) extends the connections of the injector rail and can be fitted with various adapters (e.g. injector nozzle with clamp spring, hose connections, adapters for Luer/Luer-Lock etc.).

Application

Note the following:

- The distributor cannot accommodate a filter disc. Take this into account when reprocessing instruments with an inside diameter ≤ 0.8 mm.
- The distributor extends the connections of the injector rail. It may not be combined with further multi-way distributors.

In connection with distance sleeves (art. no. ME55120) up to 9 double distributors and can be screwed on to the injector rail with a central filter.

1. Screw the double distributor onto a connection on the injector rail.
2. Tighten the distributor by hand.
3. Screw other adapters such as injector nozzles or connectors for Luer/Luer-Lock and/or hoses onto the double distributor.
PLEASE NOTE: Both connections must be occupied all the time to ensure correct function.
4. Seal the unused connections with screw plugs (art. no. ME80140).

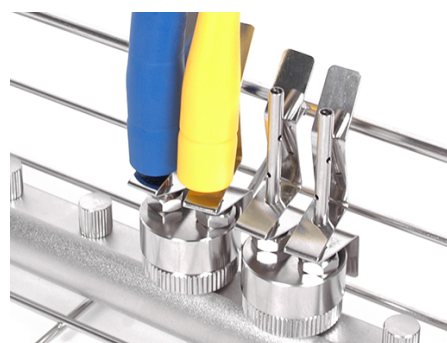

Connection example, double distributor

Used with

- Clamp spring for injector nozzle, art. no. ME00196
- Luer/Luer-Lock adapter (female), art. no. ME67250
- Injector nozzle, art. no. ME73860
- Luer adapter (male), art. no. ME73880
- Luer-Lock adapter (male), art. no. ME74130

- Screw plug for injector rail and distributors, art. no. ME80140
- Hose connector (6 mm) with external thread, art. no. ME80150
- Silicone hose (10/6 mm) with connectors, 0.5 m, art. no. ME80195

Triple distributor

The triple distributor (art. no. ME22611) extends the connections of the injector rail and can be fitted with various adapters (e.g. injector nozzle, hose connections, adapters for Luer/Luer-Lock etc.).

Application

Note the following:

- The distributor cannot accommodate a filter disc. Take this into account when reprocessing instruments with an inside diameter ≤ 0.8 mm. If filtered water is required and no central filter is available, then use the triple distributor incl. ceramic filter disc (art. no. ME73903).
- The distributor extends the connections of the injector rail. It may not be combined with further multi-way distributors.

In connection with distance sleeves (art. no. ME55120) up to 11 triple distributors can be screwed on to the injector rail with a central filter.

1. Screw the triple distributor onto a connection on the injector rail.
2. Tighten the distributor by hand.
3. Screw other adapters such as injector nozzles or connectors for Luer/Luer-Lock and/or hoses onto the triple distributor.
PLEASE NOTE: All connections must be occupied all the time to ensure correct function.
4. Seal the unused connections with screw plugs (art. no. ME80140).



Connection example, triple distributor

Used with

- Clamp spring for injector nozzle, art. no. ME00196
- Luer/Luer-Lock adapter (female), art. no. ME67250
- Injector nozzle, art. no. ME73860
- Luer adapter (male), art. no. ME73880
- Luer-Lock adapter (male), art. no. ME74130
- Screw plug for injector rail and distributors, art. no. ME80140
- Hose connector (6 mm) with external thread, art. no. ME80150
- Silicone hose (10/6 mm) with connectors, 0.5 m, art. no. ME80195

Triple distributor (incl. ceramic filter disc)

The triple distributor (art. no. ME73903) extends the connections of the injector rail and can be fitted with various adapters (e.g. injector nozzle, hose connections, adapters for Luer/Luer-Lock etc.).

Application

Note the following:

- The use of filter inserts is necessary with hollow-body instruments with an interior diameter ≤ 0.8 mm. Both the reusable metal filter disc (art. no. ME80350) and the ceramic filter disc (art. no. ME64375) can be used.
- For hollow-body instruments with an inner diameter > 0.8 mm, remove the filter disc.
- The distributor extends the connections of the injector rail. It may not be combined with further multi-way distributors.
- If you use the injector rail with central filter, then remove the filter disc from the triple distributor.
- Comply with the regular replacement intervals for the filter inserts, see [Filter inserts](#) [► page 72].

In connection with distance sleeves (art. no. ME55120) up to 9 triple distributors can be screwed on to the injector rail with a central filter.

1. Screw the triple distributor (pos. a) onto a connection on the injector rail.
2. Tighten the distributor by hand.
3. Screw other adapters such as injector nozzles or connectors for Luer/Luer-Lock and/or hoses onto the triple distributor.
PLEASE NOTE: All connections must be occupied all the time to ensure correct function.
4. Seal the unused connections with screw plugs (pos. b, art. no. ME80140).

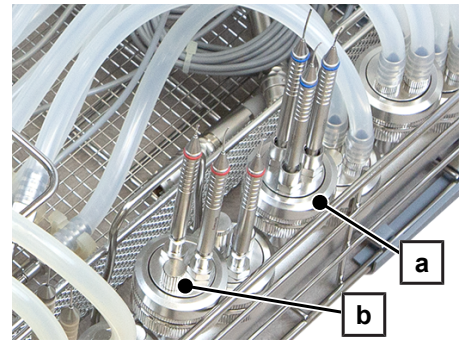

Connection example, triple distributor

Inserting/replacing the ceramic/metal filter disc

1. Rinse the re-usable metal filter disc (pos. e) under running water before initial use.
Rinse the new ceramic filter disc (pos. d) briefly under running water.
2. Insert the filter disc in the yellow silicone insert (pos. c).
3. Insert the yellow silicone insert in the lower section (pos. f) of the triple distributor with the filter disc pointing downwards.
PLEASE NOTE: Insert the silicone insert with the re-usable metal filter disc in the housing. The printed side of the metal filter disc **must always point downwards**.
4. Place the distributor plate (pos. b) on the yellow silicone insert.
5. Place the upper section (pos. a) of the triple distributor over the distributor plate on the lower section and screw them together hand-tight.

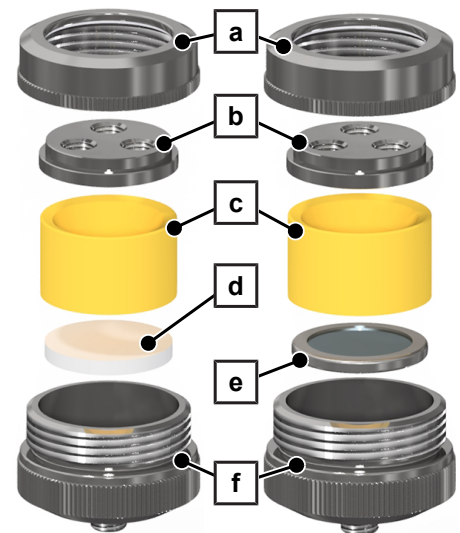

Used with

- Basis basket with injector rail incl. 11 injector nozzles and clamp springs, art. no. ME00197
- Basis basket with injector rail, art. no. ME00200
- Ceramic filter disc, art. no. ME64375
- Luer/Luer-Lock adapter (female), art. no. ME67250
- Injector nozzle, art. no. ME73860 (only without using the filter disc)
- Luer adapter (male), art. no. ME73880
- Luer-Lock adapter (male), art. no. ME74130
- Screw plug for injector rail and distributors, art. no. ME80140
- Hose connector (6 mm) with external thread, art. no. ME80150
- Silicone hose (10/6 mm) with connectors, 0.5 m, art. no. ME80195
- Metal filter disc, art. no. ME80350
- Basis basket with injector rail incl. 2 plastic central filters, art. no. ME80440
- Basis basket with injector rail incl. Cleanfinity filter, art. no. ME84610

Filter inserts



WARNING

Reduced rinse pressure

When using the basis basket with injector rail incl. central filter, do not use additional filter elements such as ceramic and metal filter discs.

- Before using a basis basket with injector rail incl. central filter, remove any existing filter elements.

Ceramic filter disc

The ceramic filter disc (art. no. ME64375) can be used in the filter disc housing, the triple distributor or the universal adapter.

The ceramic filter disc is not suitable for re-use and must be disposed of correctly after the replacement interval.

Application/replacement

Note the following:

- Hollow-body instruments with an interior diameter ≤ 0.8 mm require filter inserts.
- When using the ceramic filter disc, comply with the regular replacement intervals.

Replace the ceramic filter disc **every two weeks or after 20 cycles at the latest**, as it will become clogged with dirt particles after some time. The replacement interval also includes the cycles in which no instruments are placed on the adapters.

Replace the ceramic filter disc according to the accessory, see [Filter disc housing incl. ceramic filter disc](#) [▶ page 64], [Universal adapter incl. 3 inserts and ceramic filter disc](#) [▶ page 66] or [Triple distributor \(incl. ceramic filter disc\)](#) [▶ page 70].

Used with

- Triple distributor incl. ceramic filter disc, art. no. ME73903
- Universal adapter incl. 3 inserts and ceramic filter disc, art. no. ME73904
- Filter disc housing incl. ceramic filter disc, art. no. ME73905

Metal filter disc

The reusable metal filter disc (art. no. ME80350) can be used in the filter disc housing, the triple distributor or the universal adapter.

Application with new filter disc



WARNING

Danger of contamination

There may be manufacturing residues on brand-new metal filter discs.

- Never use a soiled or damaged metal filter disc.

Note the following:

- Hollow-body instruments with an interior diameter ≤ 0.8 mm require filter inserts.
- Do not use the reusable metal filter disc in ophthalmology. Instead, use the ceramic filter disc (art. no. ME64375).

Insert the new metal filter disc according to the accessory, see [Filter disc housing incl. ceramic filter disc](#) [▶ page 64], [Universal adapter incl. 3 inserts and ceramic filter disc](#) [▶ page 66] or [Triple distributor \(incl. ceramic filter disc\)](#) [▶ page 70].

Application/cleaning of an already used filter disc**WARNING****Risk of contamination after insufficient ultrasonic cleaning**

In rare cases, dirt particles can remain on the reusable metal filter disc after ultrasonic cleaning and can work loose during reprocessing.

**PLEASE NOTE**

The reusable metal filter disc is suitable for limited reprocessing and must be disposed of properly after 20 reprocessing runs.

Clean the metal filter disc **every two weeks or after 20 cycles at the latest**, as it will become clogged with dirt particles after some time. The interval also includes the cycles in which no instruments are placed on the adapters.

1. Remove coarse dirt particles with a plastic brush whilst under cold running water.
2. Then clean the reusable metal filter disc in an ultrasonic device at 50 °C for approx. 30 min and with an acid cleaner e.g. 35 ml/l Dr. Weigert neodisher IR in de-ionised water (DI water). Comply with the manufacturer's specifications for the ultrasonic device.
3. Rinse the reusable metal filter disc under cold running water.
4. If the reusable metal filter disc is not used directly, it must be dried and then stored in a dry location.

Used with

- Triple distributor incl. ceramic filter disc, art. no. ME73903
- Universal adapter incl. 3 inserts and ceramic filter disc, art. no. ME73904
- Filter disc housing incl. ceramic filter disc, art. no. ME73905

Plastic central filter

The plastic central filter (art. no. ME80490) is used for fine filtering of the rinse liquor of the associated injector rail.

Application

The plastic central filter may only be used with the injector rail for central filters. For the application instructions for the injector rail and plastic central filter, see [Injector rail with central filter and adapters](#) [▶ page 75].

The plastic central filter is not suitable for reprocessing and must be disposed of properly after the specified replacement intervals have expired, see [Period of use of the central filter](#) [▶ page 78].



Injector rail with plastic central filter

Note the following:

- Hollow-body instruments with an interior diameter ≤ 0.8 mm require filter inserts.
- The plastic central filter may only be stored in unopened original packaging.
- The expiry date given on the packaging of the plastic central filter may not be exceeded.
- Insert the plastic central filter into the injector rail before the storage date has expired.
- The plastic central filter may not permanently be exposed to UV light.

Used with

- Basis basket with injector rail incl. 2 plastic central filters, art. no. ME80440
- Basis basket with injector rail incl. Cleanfinity filter, art. no. ME84610

Cleanfinity filter

The Cleanfinity filter (art. no. ME84630) is a cleanable central filter and is used for fine filtering of the rinse liquor of the associated injector rail.

Application

The Cleanfinity filter may only be operated in combination with the injector rail for the central filter. For the application instructions for the injector rail and Cleanfinity filter, see [Injector rail with central filter and adapters](#) [▶ page 75].

The Cleanfinity filter is suitable for reprocessing and must be cleaned at regular intervals, see [Cleaning the Cleanfinity filter](#) [▶ page 74].

Note the following:

- Hollow-body instruments with an interior diameter ≤ 0.8 mm require filter inserts.
- Do not use the Cleanfinity filter in ophthalmology. Instead, use the plastic central filter (art. no. ME80490).

Used with

- Basis basket with injector rail incl. Cleanfinity filter, art. no. ME84610

Cleaning the Cleanfinity filter

Immediately before inserting the Cleanfinity filter into the injector rail, clean it according to the instructions.



WARNING

Risk of contamination by dirt particles during cleaning.

- Wear suitable hand and mouth protection and protective goggles during cleaning.

Checking/reprocessing the cleaning brush

Note the following:

- Only use the original cleaning brush.
 - The cleaning brush must not be taken into the clean room.
 - The cleaning brush is not suitable for reprocessing in the MELAtherm.
1. Check the cleaning brush (art. no. ME84640) for contamination and damage before cleaning the Cleanfinity filter.
 2. Replace a damaged cleaning brush.
 3. Reprocess a contaminated cleaning brush using a disinfectant immersion bath. Follow the instructions of the disinfectant manufacturer regarding the materials nylon and PVC.

Cleaning the filter

The following must be fulfilled or present:

- ✓ The cleaning brush has been checked, reprocessed or replaced.

1. Open the sealing cap (pos. a) at the end of the Cleanfinity filter.



2. Clean the Cleanfinity filter lengthwise under running water. At the same time, slide the cleaning brush through the filter (grip side first) to its fullest extent and pull it out. Repeat this procedure at least three times, until the central filter is visibly clean.



3. In case of stubborn soiling, use an additional compressed air gun or a MELAjet spray pistol for cleaning from the outside.
4. Close the Cleanfinity filter again using the sealing cap (pos. a). Make sure that the bayonet lock (pos. b) is positioned and locked correctly.

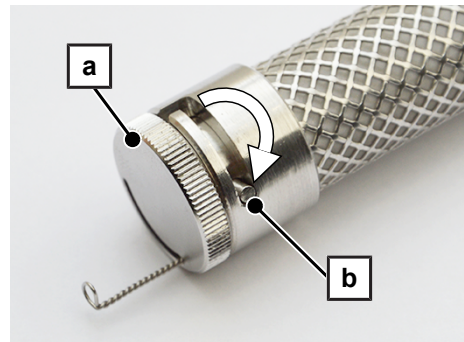

Injector rail with central filter and adapters



WARNING

Danger of contamination from soiling on a brand-new central filter

- Only use a clean central filter.
- Rinse the new central filter thoroughly under running water. Alternatively, the central filter can be cleaned without load in the “Rinsing” program.

Inserting the central filter into the injector rail and removal

Cleaning and checking the Cleanfinity filter

The Cleanfinity filter can be used several times. Before inserting it into the injector rail, the Cleanfinity filter must be cleaned and checked.

The plastic central filter must be replaced after defined intervals and disposed of properly. The plastic central filter does not require any further preparation during replacement.

1. Clean the Cleanfinity filter according to the instructions, see [Cleaning the Cleanfinity filter](#) [▶ page 74].
2. Check the Cleanfinity filter for dirt and damage using daylight or a bright light source. The filter is translucent.
 - If little or no light shines through in places, the filter must be cleaned.
 - If more light shines through in places, this indicates damage and the filter must be replaced.
3. Check that the Cleanfinity filter is correctly closed and locked. The bayonet lock must be in the locked position.

Inserting the central filter into the injector rail**WARNING****Danger of contamination by a damaged central filter**

The central filter can suffer damage through incorrect insertion or removal.

- Check the central filter for damage before inserting it.
- Do not use any tools to avoid damage.

1. Slide the Cleanfinity filter (pos. a) or the plastic central filter (pos. b) into the injector rail with the closed end first.
 - ↳ If the central filter is difficult to insert, contact the technical service.
2. Tighten the handle clockwise by hand.
 - ↳ The central filter has been inserted correctly when the grip is flush with the injector rail.

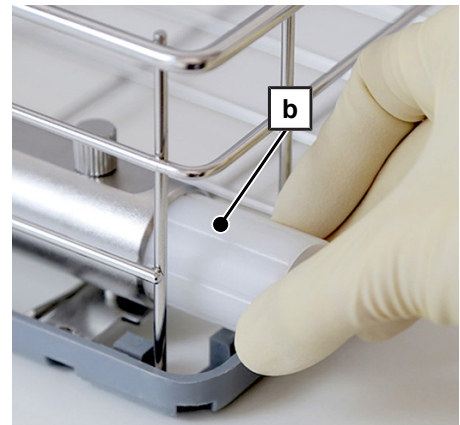
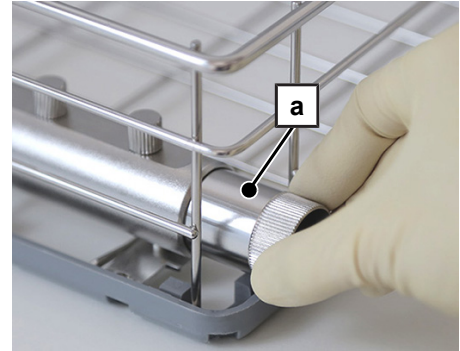

Inserting the central filter

Removing the central filter from the injector rail

Do not use any tools to remove the central filter so as to prevent damage.

- ▶ Turn the grip of the central filter anti-clockwise and working carefully, pull it out of the injector rail.

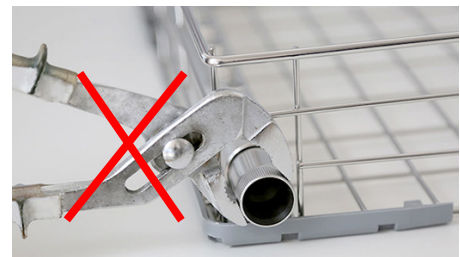

Removing the central filter without tools

Control indicator of the injector rail

The integrated control indicator of the injector rail triggers once a minimum rinse pressure has been reached. The rinse pressure achieved depends on the state of the central filter and the fitting of the injector rail.



WARNING

Danger of contamination

If proper rinse pressure is not built up, the result is reduced filtration and cleaning performance.

- Use the control indicator to check whether the central filter is functioning correctly.
- Activate the control indicator before every program run.
- Check the control indicator after every program run.

Activating the control indicator

The following must be fulfilled or present:

- ✓ The basis basket has been inserted into the washing chamber.
- 1. Press the pin (pos. a) of the control indicator into the injector rail so that it returns to its starting position.
- 2. Start a reprocessing program.
- 3. After the program run, check whether the control indicator has triggered.
 - ➔ If the control indicator pin protrudes from the injector rail (pos. b), the central filter can be used further.
 - ➔ If the pin does not protrude from the control indicator after the program run (pos. c), clean the Cleanfinity filter (see [Cleaning the Cleanfinity filter](#) ▶ page 74]) or replace the plastic central filter.

If the control indicator has not triggered the first time and the injector rail has been correctly fitted with instruments/plugs, a safety extra allows this program run can be qualified as a success.

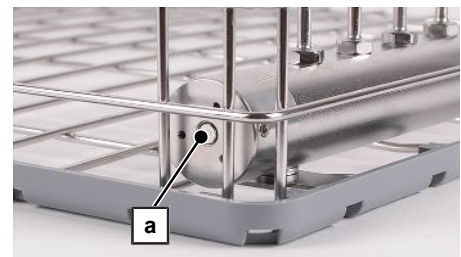

Control indicator before program start

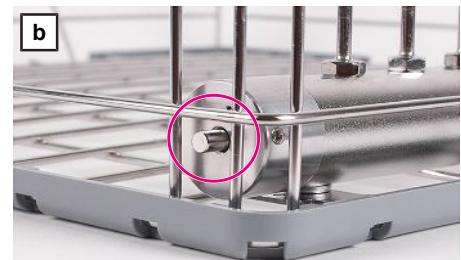

Control indicator has triggered

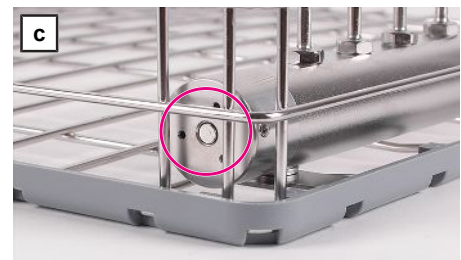

Control indicator has not triggered

Malfunctions and their remedy

Perform all the following measures before contacting the service department.

Malfunctions	Remedy
The central filter is new, but the pin does not spring out of the control indicator.	<ol style="list-style-type: none"> 1. Check whether the central filter has been inserted correctly. 2. Check the loading of the injector rail. Seal the unused connections with screw plugs (art. no. ME80140). 3. Always place instruments on adapters. If possible, seal non-used adapters with the suitable silicone closure cap. If the first two points do not bring a remedy, contact the customer services/stockist technician.
The control indicator pin cannot be pressed in.	Contact customer services / the stockist technician.

Converting to a new injector rail incl. Cleanfinity filter

You will need a size 3 Allen key and a size TX20 Torx key for the Upgrade kit injector rail incl. Cleanfinity filter (art. no. ME84620).

You do not require a conversion set for upgrading from a plastic central filter to a Cleanfinity filter or vice versa.



PLEASE NOTE

Read the application usage advice before using the accessories.

1. Remove the two screws (pos. e) on the underside of the basis basket (pos. a). Remove the previous injector rail (pos. b).
2. Dispose of the screws and distance sleeves (pos. c) of the previous injector rail.
3. Insert the new injector rail (pos. b) into the basis basket.
PLEASE NOTE: Observe the alignment of the injector rail when inserting. The central filter grip must be positioned in the aperture of the basis basket.
4. Fix the injector rail with the screws (pos. e), flat washers (pos. d) and distance sleeves (pos. c) included in the scope of delivery.
5. When using the injector rail with central filter, see the section [Injector rail with central filter and adapters](#) ▶ page 75].

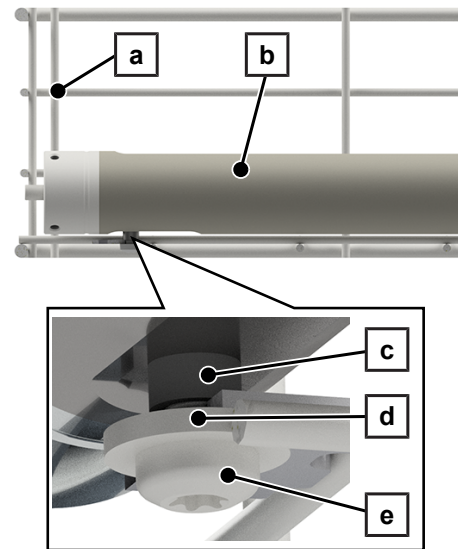

WARNING

Reduced rinse pressure

When using the basis basket with injector rail incl. central filter, do not use additional filter elements such as ceramic and metal filter discs.

- Before using a basis basket with injector rail incl. central filter, remove any existing filter elements.

Period of use of the central filter

The period of use of the central filters depends on the frequency of use, the loading of the injector rail, the water quality and the degree of soiling of the instruments to be reprocessed. As a result, it can vary strongly. For this reason, it is not possible to make a general statement about the replacement interval of the plastic central filter (art. no. ME80490) or the cleaning interval of the Cleanfinity filter (art. no. ME84630).

Ageing processes mean that the plastic central filter must be replaced **after a year at the latest**, even if the control indicator indicates sufficient rinse pressure.

Observe the following to extend the period of use of the central filters:

- Always place instruments on the adapters. If possible, seal non-used adapters with the suitable silicone closure cap.
- Seal the unused connections on the injector rail with screw plugs (art. no. ME80140). This produces a higher rinse pressure and reduces the water flow through the central filter.
- Reduce the number of connections on the injector rail. The lower the number of connections, the longer the use duration of a central filter.
- Avoid using instruments which do not require filtration. Their high water flow reduces the rinse pressure and thus the period of use of a central filter. Universal dental aspirator tips with 11 mm and 16 mm connections can be reprocessed in instrument baskets in a standing position. The distal end must point upwards. This must be considered separately during validation.
- Rinse coarse water-insoluble material (e.g. prophylaxis powder, dental cement, composite filler etc.) from the instruments before reprocessing in the washer-disinfector.

Equipping the injector rail with adapters



WARNING

Danger of contamination from reduced filtration and cleaning performance

Screwing on accessories too deeply can damage the central filter or impede the water flow in the instrument.

- Check the thread lengths with the thread length meter included.
- Use flat washers for adapters with a thread length > 4 mm.

Note the following:

- Original MELAG accessories may have a thread longer than 4 mm.
1. Remove the central filter from the injector rail.
 2. With adapters with a thread length > 4 mm add as many flat washers until the thread protrudes by max. 4 mm.
 3. Screw the connections and the adapters into the injector rail.
 4. Always place instruments on the adapters. If possible, seal non-used adapters with the suitable silicone closure cap.
 5. Insert the central filter in the injector rail.
 6. Should the central filter become difficult to slide in or becomes blocked, use further flat washers.
 7. Seal the unused connections with screw plugs (art. no. ME80140).

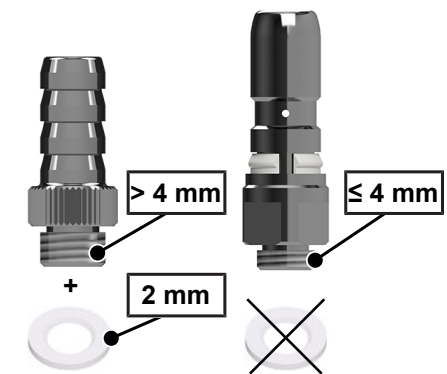

Adapters with different thread lengths

Sealing elements

Silicone closure caps

The silicone closure caps (art. no. ME89051, ME89061, ME89071) are used to seal adapters when they are not fitted with an instrument.

The scope of delivery includes 10 green, blue and white closure caps each.

Application

- ▶ Slide the silicone closure cap as far onto the adapter until it is tight.
 - PLEASE NOTE:** Do not push the silicone closure cap completely onto the adapter so that you can pull it off more easily after use.
 - Mind that fitting and removing in a dry state can be difficult.

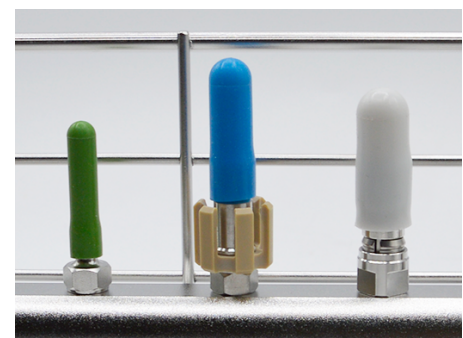

Example application, silicone closure caps

Used with

Silicone closure cap, green:

- Injector nozzle, art. no. ME73860
- Adapters for tips, art. no. ME80750, ME80751, ME80752, ME80753, ME80755, ME80756, ME80757, ME80760, ME80771, ME80790

Silicone closure cap, blue:

- Hose connector (6 mm) with external thread, art. no. ME80150
- Adapter for Sirona T1 Classic, art. no. ME80620
- Adapter for turbines with W&H connector (Roto Quick), art. no. ME80640
- Adapter for turbines with Sirona connector, art. no. ME80650
- Adapter for turbines with KaVo connector (MULTIflex), art. no. ME80660

Silicone closure cap, white:

- Adapter for ISO connector (INTRA), art. no. ME80610
- Adapter for turbines NSK connector, art. no. ME80612
- Adapter for EMS AIR-FLOW Handy 3.0, art. no. ME80613
- Adapter for EMS AIR-FLOW Prophylaxis Master, art. no. ME80614
- Adapter for contra angle heads KaVo/BienAir, art. no. ME80630

Screw plug for injector rail and distributors

The screw plug (art. no. ME80140) is used to seal non-required connections on the injector rail or on distributors.

Application

- ▶ Screw the screw plug into a connection that is not in use.



Injector rail with screw plugs

Closure (male) for Luer-Lock

The closure (male) for Luer-Lock is (art. no. ME80170) used to seal a Luer-Lock adapter (female).

Application

- ▶ Screw the closure onto a Luer-Lock adapter (e.g. when not in use) to seal it and thus prevent the rinse pressure from dropping.

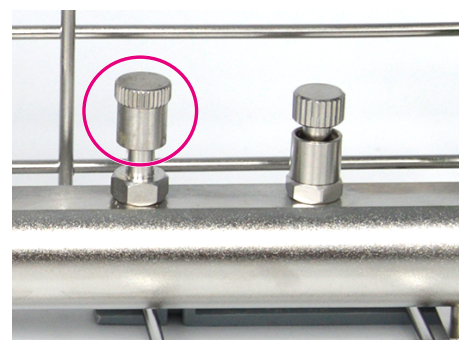

Luer/Luer-Lock adapter (female) with closure (male)

Used with

- Luer/Luer-Lock adapter (female), art. no. ME67250

Closure (female) for Luer/Luer-Lock

The closure (female) for Luer/Luer-Lock (art. no. ME80180) is used to seal a Luer-Lock adapter (male).

Application

- ▶ Screw the closure onto a Luer/Luer-Lock adapter (e.g. when not in use) to seal it and thus prevent the rinse pressure from dropping.

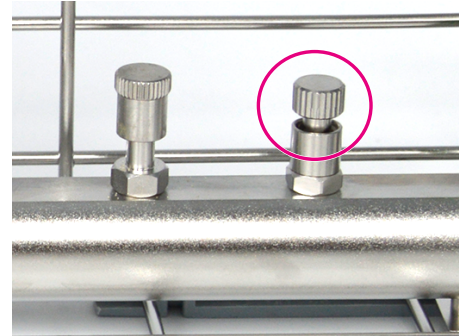

Luer-Lock adapter (male) with closure (female)

Used with

- Luer adapter (male), art. no. ME73880
- Luer-Lock adapter (male), art. no. ME74130

Hoses and hose connections

Note the following:

- Install the hoses free of kinks and sacks.
- Keep the storage duration as short as possible. Water can accumulate in long hoses.
- Do not close hoses.
- Check the hoses, connections and instruments before and after reprocessing to ensure that they are tight. If a hose, connection or instrument has come loose, reprocess the instruments again.

Hose connector (6 mm) with external thread

The hose connector (art. no. ME80150) connects hoses with a 6 mm interior diameter with the injector rail, the filter disc housing or a distributor.

Application with instruments

- ▶ Screw the hose connector into a connection of the injector rail, the filter disc housing or a distributor.



Connection example injector basket Flex 1 with injector rail

Application without instruments**PLEASE NOTE****Reduced rinse pressure**

The hose connection must always be connected to ensure functionality.

- Replace unused hose connections with a screw plug (art. no. ME80140).

- ▶ Close adapters with a suitable silicone closure cap if they are not fitted with an instrument. For more information on application, see [Sealing elements](#) [▶ page 79].

Used with

- Triple distributor, art. no. ME22611
- Triple distributor incl. ceramic filter disc, art. no. ME73903
- Filter disc housing incl. ceramic filter disc, art. no. ME73905
- Silicone hose (10/6 mm), 2 m, art. no. ME80190
- Only MELAtherm 10:
Double distributor, art. no. ME80200
- Silicone closure cap, blue, art. no. ME89061

Hose connector (6 mm) with internal thread

With the hose connector with internal thread (art. no. ME80160), a connection of the injector rail can be installed through a hose with an internal diameter of 6 mm, e.g. if very long hollow bodies are to be reprocessed that can only fit lying down in a flex basket.

Application

1. Plug the hose connector (pos. b) onto the free end of the hose.
2. Connect the adapter (pos. a) to the internal thread.

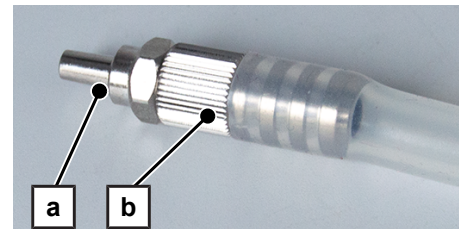

Connection example with Luer adapter (male)

Used with

- Silicone hose (10/6 mm), 2 m, art. no. ME80190

Silicone hose

The silicone hose (art. no. ME80190) is used to connect instruments to connections or to move connections on the injector rail. Instruments with a hose connection can also be pressed into the hose.

Application with instruments

1. Cut the hose to the required length. **PLEASE NOTE:** Avoid unnecessarily long hoses.
2. Connect the hose to the appropriate hose connection.

Application without instruments

- ▶ Remove long hoses when not in use.

Used with

- Hose connector (6 mm) with external thread, art. no. ME80150
- Hose connector (6 mm) with internal thread, art. no. ME80160

Silicone hose with connectors

The silicone hose with connectors (art. no. ME80195) enables connections on the injector rail to be moved, e.g. if very long hollow-body instruments are to be reprocessed which only fit lying down in a flex basket.

The scope of delivery includes a silicone hose with a length of 0.5 m incl. one hose connection each with internal and external thread.

Application with instruments

1. Cut the hose to the required length. **PLEASE NOTE:** Avoid unnecessarily long hoses.
2. Connect the hose to the appropriate hose connection.

Application without instruments

- ▶ Remove long hoses when not in use.

Used with

- Triple distributor, art. no. ME22611
- Triple distributor incl. ceramic filter disc, art. no. ME73903
- Filter disc housing incl. ceramic filter disc, art. no. ME73905
- Only MELAtherm 10:
Double distributor, art. no. ME80200
- Flex basket 6, art. no. ME80255
- Rinse sleeve incl. 5 inserts, art. no. ME80260

8 Examples for the basic configuration

Basic configuration for an ENT practice

Video tutorial

See also “Loading: ENT practice”.



- Instrument basket compact, art. no. ME00195
- Basis basket with injector rail, art. no. ME00200
- Flex basket 2, art. no. ME80020
- Flex basket 3, art. no. ME80030
- Top frame for ear specula Flex 2 (mesh size 20 mm), art. no. ME80090
- Top frame for nose specula Flex 1 incl. 2 fixing clamps, art. no. ME80435



Basic configuration for the gynaecological practice

Video tutorial

See also “Loading: Gynaecological practice”.



- Basis basket without injector rail, art. no. ME00188
- Flex basket 6, art. no. ME80255
- Flex basket specula, art. no. ME80410



Basic configuration for the dental practice

Video tutorial

See also “Loading: Dental practice”.



- Small parts basket Standard, art. no. ME00133
- Holder for 3 MELAstore Trays/sieve cassettes, art. no. ME00180
- Instrument basket standard, art. no. ME00184
- Basis basket with injector rail incl. 11 injector nozzles and clamp springs, art. no. ME00197
- MELAstore Tray 100 (27.5 x 17.6 x 3.0 cm), art. no. ME01181
- Flex basket 2, art. no. ME80020
- Holder for impression trays and instruments with joints, art. no. ME80110

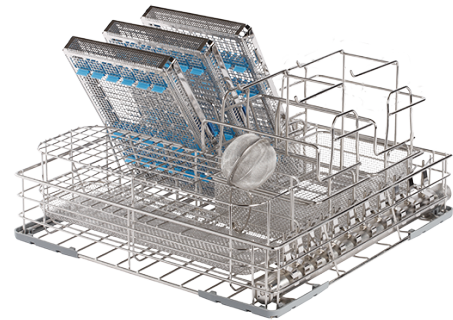

Basic configuration for the general medical practice / surgery

Video tutorial

See also “Loading: Medical practices”.



- Basis basket with injector rail, art. no. ME00200
- Flex basket 3, art. no. ME80030
- Flex basket 6, art. no. ME80255



9 Spare parts

All specified articles are available through specialist dealers.

Accessories		Spare parts	Art. no.
Adapters for transmission instruments	Adapter for EMS AIR-FLOW Handy 3.0	Clip and spring for EMS AIR-FLOW adapter	ME22965
	Adapter for EMS AIR-FLOW Prophylaxis Master	Sleeve for EMS AIR-FLOW adapter	ME22963
		Silicone sleeve for EMS AIR-FLOW adapter	ME22964
		Clip and spring for EMS AIR-FLOW adapter	ME22965



MELAG Medizintechnik GmbH & Co. KG

Geneststraße 6-10
10829 Berlin
Germany

Email: info@melag.com
Web: www.melag.com

Original instructions

Responsible for content: MELAG Medizintechnik GmbH & Co. KG
We reserve the right to technical alterations

Your stockist